

INSTRUCTIONS

D-ILA PROJECTOR

DLA-RS66
DLA-RS56
DLA-RS48
DLA-RS46

D-ILA[®]
HDMI[®]
HIGH-DEFINITION MULTIMEDIA INTERFACE

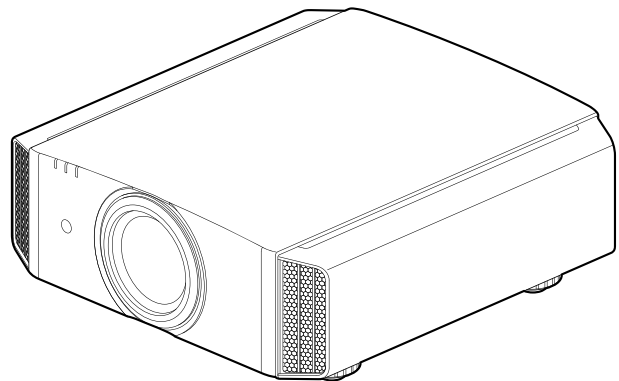

For Customer use :

Enter below the serial No. which is located on the side of the cabinet. Retain this information for future reference.

Model No. DLA-RS66 / DLA-RS56 /
DLA-RS48 / DLA-RS46

Serial No. _____

Pour utilisation par le client :

Entrer-ci-dessous le N° de série qui est situé sous le boîtier. Garder cette information comme référence pour le futur.

N° de modèle DLA-RS66 / DLA-RS56 /
DLA-RS48 / DLA-RS46

N° de série _____

Instrucción para el cliente :

Introduzca a continuación el n° de serie que aparece en la parte inferior lateral de la caja. Conserve esta información como referencia para uso ulterior.

Modelo N° DLA-RS66 / DLA-RS56 /
DLA-RS48 / DLA-RS46

N° de serie _____

Safety Precautions

IMPORTANT INFORMATION

This product has a High Intensity Dis-charge (HID) lamp that contains mercury.

Disposal of these materials may be regulated in your community due to environmental considerations. For disposal or recycling information, please contact your local authorities or for USA, the Electronic Industries Alliance: <http://www.eiae.org>.

WARNING:

TO PREVENT FIRE OR SHOCK HAZARDS, DO NOT EXPOSE THIS APPLIANCE TO RAIN OR MOISTURE.

WARNING:

THIS APPARATUS MUST BE EARTHED.

CAUTION:

To reduce the risk of electric shock, do not remove cover. Refer servicing to qualified service personnel.

This projector is equipped with a 3-blade grounding type plug to satisfy FCC rule. If you are unable to insert the plug into the outlet, contact your electrician.

MACHINE NOISE INFORMATION (Germany only)

Changes Machine Noise Information Ordinance 3. GSGV, January 18, 1991: The sound pressure level at the operator position is equal or less than 20 dB (A) according to ISO 7779.

For the customers in Taiwan only



廢電池請回收

FCC INFORMATION (U.S.A. only)

CAUTION:

Changes or modification not approved by JVC could void the user's authority to operate the equipment.

NOTE:

This equipment has been tested and found to comply with the limits for Class B digital devices, pursuant to Part 15 of the FCC Rules. These limits are designed to provide reasonable protection against harmful interference in a residential installation. This equipment generates, uses, and can radiate radio frequency energy and, if not installed and used in accordance with the instructions, may cause harmful interference to radio communications. However, there is no guarantee that interference will not occur in a particular installation. If this equipment does cause harmful interference to radio or television reception, which can be determined by turning the equipment off and on, the user is encouraged to try to correct the interference by one or more of the following measures:

- Reorient or relocate the receiving antenna.
- Increase the separation between the equipment and receiver.
- Connect the equipment into an outlet on a circuit different from that to which the receiver is connected.
- Consult the dealer or an experienced radio/TV technician for help.

Declaration of Conformity

Model Number : DLA-RS66U/DLA-RS56U/
DLA-RS48U/DLA-RS46U

Trade Name : JVC

Responsible party : JVC AMERICAS CORP.

Address : 1700 Valley Road Wayne, N. J. 07470

Telephone Number : 973-317-5000

This device complies with Part 15 of FCC Rules.

Operation is subject to the following two conditions:

- (1) This device may not cause harmful interference, and
- (2) this device must accept any interference received, including interference that may cause undesired operation.

About the installation place

Do not install the projector in a place that cannot support its weight securely.

If the installation place is not sturdy enough, the projector could fall or overturn, possibly causing personal injury.

IMPORTANT SAFEGUARDS

Electrical energy can perform many useful functions. This unit has been engineered and manufactured to assure your personal safety. But **IMPROPER USE CAN RESULT IN POTENTIAL ELECTRICAL SHOCK OR FIRE HAZARD**. In order not to defeat the safeguards incorporated into this product, observe the following basic rules for its installation, use and service. Please read these Important Safeguards carefully before use.

- All the safety and operating instructions should be read before the product is operated.
- The safety and operating instructions should be retained for future reference.
- All warnings on the product and in the operating instructions should be adhered to.
- All operating instructions should be followed.
- Place the projector near a wall outlet where the plug can be easily unplugged.
- Unplug this product from the wall outlet before cleaning.
- Do not use liquid cleaners or aerosol cleaners. Use a damp cloth for cleaning.
- Do not use attachments not recommended by the product manufacturer as they may be hazardous.
- Do not use this product near water. Do not use immediately after moving from a low temperature to high temperature, as this causes condensation, which may result in fire, electric shock, or other hazards.
- Do not place this product on an unstable cart, stand, or table. The product may fall, causing serious injury to a child or adult, and serious damage to the product. The product should be mounted according to the manufacturer's instructions, and should use a mount recommended by the manufacturer.
- When the product is used on a cart, care should be taken to avoid quick stops, excessive force, and uneven surfaces which may cause the product and cart to overturn, damaging equipment or causing possible injury to the operator.
- Slots and openings in the cabinet are provided for ventilation. These ensure reliable operation of the product and protect it from overheating. These openings must not be blocked or covered. (The openings should never be blocked by placing the product on bed, sofa, rug, or similar surface. It should not be placed in a built-in installation such as a bookcase or rack unless proper ventilation is provided and the manufacturer's instructions have been adhered to.)
- To allow better heat dissipation, keep a clearance between this unit and its surrounding as shown below. When this unit is enclosed in a space of dimensions as shown below, use an air-conditioner so that the internal and external temperatures are the same. Overheating can cause damage.

PORTABLE CART WARNING
(symbol provided by RETAC)

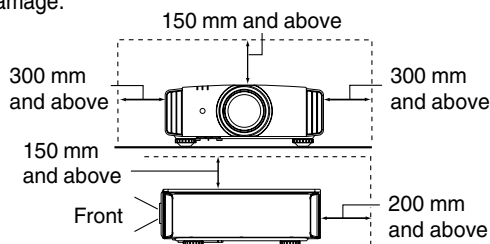

- Power source indicated on the label. If you are not sure of the type of power supply to your home, consult your product dealer or local power company.
- This product is equipped with a three-wire plug. This plug will fit only into a grounded power outlet. If you are unable to insert the plug into the outlet, contact your electrician to install the proper outlet. Do not defeat the safety purpose of the grounded plug.
- Power-supply cords should be routed so that they are not likely to be walked on or pinched by items placed upon or against them. Pay particular attention to cords at doors, plugs, receptacles, and the point where they exit from the product.
- For added protection of this product during a lightning storm, or when it is left unattended and unused for long periods of time, unplug it from the wall outlet and disconnect the cable system. This will prevent damage to the product due to lightning and power line surges.
- Do not overload wall outlets, extension cords, or convenience receptacles on other equipment as this can result in a risk of fire or electric shock.
- Never push objects of any kind into this product through openings as they may touch dangerous voltage points or short out parts that could result in a fire or electric shock. Never spill liquid of any kind on the product.
- Do not attempt to service this product yourself as opening or removing covers may expose you to dangerous voltages and other hazards. Refer all service to qualified service personnel.
- Unplug this product from the wall outlet and refer service to qualified service personnel under the following conditions:
 - a) When the power supply cord or plug is damaged.
 - b) If liquid has been spilled, or objects have fallen on the product.
 - c) If the product has been exposed to rain or water.
 - d) If the product does not operate normally by following the operating instructions. Adjust only those controls that are covered by the Operation Manual, as an improper adjustment of controls may result in damage and will often require extensive work by a qualified technician to restore the product to normal operation.
 - e) If the product has been dropped or damaged in any way.
 - f) When the product exhibits a distinct change in performance, this indicates a need for service.
- When replacement parts are required, be sure the service technician has used replacement parts specified by the manufacturer or with same characteristics as the original part. Unauthorized substitutions may result in fire, electric shock, or other hazards.
- Upon completion of any service or repairs to this product, ask the service technician to perform safety checks to determine that the product is in proper operating condition.
- The product should be placed more than one foot away from heat sources such as radiators, heat registers, stoves, and other products (including amplifiers) that produce heat.
- When connecting other products such as VCR's, and DVD players, you should turn off the power of this product for protection against electric shock.

- Do not place combustibles behind the cooling fan. For example, cloth, paper, matches, aerosol cans or gas lighters that present special hazards when over heated.
- Do not look into the projection lens while the illumination lamp is turned on. Exposure of your eyes to the strong light can result in impaired eyesight.
- Do not look into the inside of this unit through vents (ventilation holes), etc. Do not look at the illumination lamp directly by opening the cabinet while the illumination lamp is turned on. The illumination lamp also contains ultraviolet rays and the light is so powerful that your eyesight can be impaired.
- Do not drop, hit, or damage the light-source lamp (lamp unit) in any way. It may cause the light-source lamp to break and lead to injuries. Do not use a damaged light source lamp. If the light-source lamp is broken, ask your dealer to repair it. Fragments from a broken light-source lamp may cause injuries.
- The light-source lamp used in this projector is a high pressure mercury lamp. Be careful when disposing of the light-source lamp. If anything is unclear, please consult your dealer.
- Do not ceiling-mount the projector to a place which tends to vibrate; otherwise, the attaching fixture of the projector could be broken by the vibration, possibly causing it to fall or overturn, which could lead to personal injury.
- Use only the accessory cord designed for this product to prevent shock.
- For health reasons, please take a break of about 5-15 minutes every 30-60 minutes and let your eyes rest. Please refrain from watching any 3D-images when you feel tired, unwell or if you feel any other discomfort. Moreover, in case you see a double image, please adjust the equipment and software for proper display. Please stop using the unit if the double image is still visible after adjustment.
- Once every three years, please perform an internal test. This unit is provided with replacement parts needed to maintain its function (such as cooling fans). Estimated replacement time of parts can vary greatly depending on frequency of use and the respective environment. For replacement, please consult your dealer, or the nearest authorized JVC service center.
- When fixing the unit to the ceiling, Please note that we do not take any responsibility, even during the warranty period, if the product is damaged due to use of metal fixtures used for fixation to the ceiling other than our own or if the installation environment of said metal fixtures is not appropriate. If the unit is suspended from the ceiling during use, please be careful in regard to the ambient temperature of the unit. If you use a central heating, the temperature close to the ceiling will be higher than normally expected.
- Video images can burn into the electronic component parts. Please do not display screens with still images of high brightness or high contrast, such as found in video games and computer programs. Over a long period of time it might stick to the picture element. There is no problem with the playback of moving images, e.g. normal video footage.
- Video images can burn into the electronic component parts. Please do not display screens with still images of high brightness or high contrast, such as found in video games and computer programs. Over a long period of time it might stick to the picture element. There is no problem with the playback of moving images, e.g. normal video footage.
- Not using the unit for a long time can lead to malfunction. Please power it on and let it run occasionally. Please avoid using the unit in a room where cigarettes are smoked. It is impossible to clean optical component parts if they are contaminated by nicotine or tar. This might lead to performance degradation.
- Please watch from a distance three times the height of the projected image size. Persons with photosensitivity, any kind of heart disease, or weak health should not use 3D glasses.
- Watching 3D-images might be cause of illness. If you feel any change in your physical condition, please stop watching immediately and consult a physician if necessary.
- When watching 3D images, it is recommended to take regular breaks. As the length and frequency of the required breaks differ for every person, please judge according to your own condition.
- If your child watches while wearing 3D glasses, it should be accompanied by its parents or an adult guardian. The adult guardian should be careful to avoid situations where the child's eyes might become tired, as responses to tiredness and discomfort, etc., are hard to detect, and it is possible for the physical condition to deteriorate very quickly. As the visual sense is not yet fully developed in children under the age of 6, please consult a physician in regard to any problem concerning 3D-images if necessary.
- Note that when using the 3D feature, the video output may appear different from the original video image due to image conversion on the device.

*** DO NOT allow any unqualified person to install the unit.**

Be sure to ask your dealer to install the unit (e.g. attaching it to the ceiling) since special technical knowledge and skills are required for installation. If installation is performed by an unqualified person, it may cause personal injury or electrical shock.

POWER CONNECTION

For USA and Canada only
Use only the following power cord.

Power cord



The power supply voltage rating of this product is AC110V – AC240V. Use only the power cord designated by our dealer to ensure Safety and EMC. Ensure that the power cable used for the projector is the correct type for the AC outlet in your country. Consult your product dealer.

Power cord

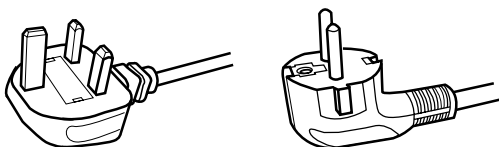

For United Kingdom

For European continent
countries

WARNING:

Do not cut off the main plug from this equipment.

If the plug fitted is not suitable for the power points in your home or the cable is too short to reach a power point, then obtain an appropriate safety approved extension lead or adapter or consult your dealer. If nonetheless the mains plug is cut off, dispose of the plug immediately, to avoid a possible shock hazard by inadvertent connection to the main supply. If a new main plug has to be fitted, then follow the instruction given below.

WARNING:

THIS APPARATUS MUST BE EARTHED.

Dear Customer,

This apparatus is in conformance with the valid European directives and standards regarding electromagnetic compatibility and electrical safety.

European representative of JVC KENWOOD Corporation is:

JVC Technical Services Europe GmbH
Postfach 10 05 04
61145 Friedberg
Germany

IMPORTANT (Europe only):

The wires in the mains lead on this product are colored Vert et jaune in accordance with the following cord:

Green-and-yellow : Earth
Blue : Neutral
Brown : Live

As these colors may not correspond with the colored making identifying the terminals in your plug, proceed as follows:

The wire which is colored green-and-yellow must be connected to the terminal which is marked M with the letter E or the safety earth or colored green or green-and-yellow. The wire which is colored blue must be connected to the terminal which is marked with the letter N or colored black.

The wire which is colored brown must be connected to the terminal which is marked with the letter L or colored red.

POWER CONNECTION (United Kingdom only)

IMPORTANT (Europe only):

When replacing the fuse, be sure to use only a correctly rated approved type, re-fit the fuse cover.

IF IN DOUBT — CONSULT A COMPETENT ELECTRICIAN.

Open the fuse compartment with the blade screwdriver, and replace the fuse.

(* An example is shown in the illustration below.)

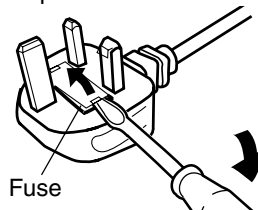

Information for Users on Disposal of Old Equipment and Batteries



Products



Battery

[European Union only]

These symbols indicate that equipment with these symbols should not be disposed of as general household waste. If you want to dispose of the product or battery, please consider the collection systems or facilities for appropriate recycling.

Notice: The sign Pb below the symbol for batteries indicates that this battery contains lead.

Benutzerinformationen zur Entsorgung alter Geräte und Batterien



Produkte



Batterie

[Nur Europäische Union]

Diese Symbole zeigen an, dass derartig gekennzeichnete Geräte nicht als normaler Haushaltsabfall entsorgt werden dürfen. Weichen Sie sich zur Entsorgung des Produkts oder der Batterie an die hierfür vorgesehenen Sammelstellen oder Einrichtungen, damit eine fachgerechte Wiederverwertung möglich ist.

Hinweis: Das Zeichen Pb unterhalb des Batteriesymbols gibt an, dass diese Batterie Blei enthält.

Informations relatives à l'élimination des appareils et des piles usagés, à l'intention des utilisateurs



Produits



Pile

[Union européenne seulement]

Si ces symboles figurent sur les produits, cela signifie qu'ils ne doivent pas être jetés comme déchets ménagers. Si vous voulez jeter ce produit ou cette pile, veuillez considérer le système de collection de déchets ou les centres de recyclage appropriés.

Notification: La marque Pb en dessous du symbole des piles indique que cette pile contient du plomb.

Informatie voor gebruikers over het verwijderen van oude apparatuur en batterijen



Producten



Batterij

[Alleen Europese Unie]

Deze symbolen geven aan dat apparatuur met dit symbool niet mag worden weggegooid als algemeen huishoudelijk afval. Als u het product of de batterij wilt weggooien, kunt u inzamelsystemen of faciliteiten voor een geschikte recycling gebruiken.

Opmerking: Het teken Pb onder het batterijsymbool geeft aan dat deze batterij lood bevat.

Información para los usuarios sobre la eliminación de baterías/pilas usadas



Productos



Baterías/pilas

[Sólo Unión Europea]

Estos símbolos indican que el equipo con estos símbolos no debe desecharse con la basura doméstica. Si desea desechar el producto o batería/pila, acuda a los sistemas o centros de recogida para que los reciclen debidamente.

Atención: La indicación Pb debajo del símbolo de batería/pila indica que ésta contiene plomo.

Informazioni per gli utenti sullo smaltimento delle apparecchiature e batterie obsolete



Prodotti



Batteria

[Solo per l'Unione Europea]

Questi simboli indicano che le apparecchiature a cui sono relativi non devono essere smaltite tra i rifiuti domestici generici. Se si desidera smaltire questo prodotto o questa batteria, prendere in considerazione i sistemi o le strutture di raccolta appropriati per il riciclaggio corretto.

Nota: Il simbolo Pb sotto il simbolo delle batterie indica che questa batteria contiene piombo.

Informação para os utilizadores acerca da eliminação de equipamento usado e pilhas



Produtos



Pilha

[Apenas União Europeia]

Estes símbolos indicam que o equipamento com estes símbolos não deve ser eliminado juntamente com o restante lixo doméstico. Se pretende eliminar o produto ou a pilha, utilize os sistemas de recolha ou instalações para uma reciclagem apropriada.

Aviso: O sinal Pb abaixo do símbolo para pilhas indica que esta pilha contém chumbo.

Πληροφορίες για την απόρριψη παλαιού εξοπλισμού και μπαταριών



Προϊόντα



Μπαταρία

[Ευρωπαϊκή Ένωση μόνο]

Αυτά τα σύμβολα υποδηλώνουν ότι ο εξοπλισμός που τα φέρει δεν θα πρέπει να απορριφθεί ως κοινό οικιακό απόρριμμα. Εάν επιθυμείτε την απόρριψη αυτού του προϊόντος ή αυτής της μπαταρίας, χρησιμοποιήστε το σύστημα περισυλλογής ή εγκαταστάσεις για ανάλογη ανακύκλωση.

Σημείωση: Το σύμβολο Pb κάτω από το σύμβολο μπαταρίας υποδηλώνει ότι η μπαταρία περιέχει μόλυβδο.

Brugerinformation om bortskaffelse af gammelt udstyr og batterier



Produkter



Batteri

[Kun EU]

Disse symboler angiver, at udstyr med disse symboler ikke må bortskaffes som almindeligt husholdningsaffald. Hvis du ønsker at smide dette produkt eller batteri ud, bedes du overveje at bruge indsamlingssystem et eller steder, hvor der kan ske korrekt gen brug.

Bemærk: Tegnet Pb under symbolet for batterierne angiver, at dette batteri indeholder bly.

Tietoja vanhojen laitteiden ja akkujen hävittämisestä



Tuotteet



Akku

[Vain Euroopan unioni]

Nämä symbolit ilmaisevat, että symboleilla merkittyä laitetta ei tulisi hävittää tavallisen kotitalousjätteen mukana. Jos haluat hävit tää tuotteen tai sen akun, tee se hyödyntämällä akkujen keräyspisteitä tai muita kier rätyspaikkoja.

Huomautus: Akkusymbolin alapuolella oleva Pb-merk intä tarkoittaa, että akku sisältää lyijyä.

SVENSKA

Information för användare gällande bortskaffning av gammal utrustning och batterier



Produkter



Batteri

[Endast den Europeiska unionen]

Dessa symboler indikerar att utrustning med dessa symboler inte ska hanteras som vanligt hushållsavfall. Om du vill bortskaffa produkten eller batteriet ska du använda uppsamlingssystem eller inrättningar för lämplig återvinning.

Observera: Märkningen Pb under symbolen för batterier indikerar att detta batteri innehåller bly.

NORSK

Opplysninger til brukere om kassering av gammelt utstyr og batterier



Produkter



Batteri

[Bare EU]

Disse symbolene viser at utstyr med dette symbolet, ikke skal kastes sammen med vanlig husholdningsavfall. Hvis du vil kasse dette produktet eller batteriet, skal du vurdere å bruke innsamlingsystemene eller andre muligheter for riktig gjenbruk.

Merk: Tegnet Pb under symbolet for batterier, viser at batteriet inneholder bly.

РУССКИЙ

Сведения для пользователей по утилизации старого оборудования и батарей



Изделия



Батарея

[только для Европейского союза]

Данные символы указывают на то, что оборудование, на которое они нанесены, не должны утилизироваться, как обычные бытовые отходы. При необходимости утилизировать такое изделие или батарею обратитесь в специальный пункт сбора для их надлежащей переработки.

Уведомление: Надпись Pb под символом батареи указывает на то, что данная батарея содержит свинец.

ČESKY

Informace pro uživatele k likvidaci starého zařízení a baterií



Produkty



Baterie

[Pouze Evropská unie]

Tyto symboly označují, že produkty s těmito symboly se nesmí likvidovat jako běžný odpad. Pokud chcete produkt nebo baterii zlikvidovat, využijte sběrný systém nebo jiné zařízení, které zajistí řádnou recyklaci.

Bemærk: Značka Pb pod symbolem pro baterie znamená, že tato baterie obsahuje olovo.

POLSKI

Informacje dla użytkowników dotyczące pozbywania się zużytego sprzętu i baterii



Produkty



Bateria

[Tylko kraje Unii Europejskiej]

Te symbole oznaczają, że sprzęt tu nie należy wyrzucać razem z odpadami gospodarczymi. Jeśli trzeba po zbyciu tego produktu lub baterii, proszę skorzystać z systemu odbioru lub urządzeń do zbiórki odpadów elektronicznych, w celu odpowiedniego ponownego ich przetworzenia.

Uwaga: Oznaczenie Pb, znajdujące się pod symbolem baterii wskazuje, że ta bateria zawiera ołów.

Felhasználói információ az elhasznált be rendezések és akkumulátorok elhelyezéséről

Termékek



Akkumulátor

[Csak az Európai Unióban]

Ez a szimbólum azt jelzi, hogy a berendezés nem helyezhető az általános háztartási hulladék közé. Ha meg szeretne szabadulni a terméktől vagy az akkumulátortól, akkor legyen tekintettel az gyűjtő rendszerre vagy intézményekre a megfelelő hasznosítás érdekében.

Megjegyzés: Az alábbi Pb szimbólum - ha az akkumulátoron megtalálható - azt jelzi, hogy az akkumulátor ólmot tartalmaz.

Informacije za korisnike o odlaganju stare opreme i baterija

Produkt



Baterija

[Samo u zemljama gde se primenjuje]

Ovi simboli ukazuju da proizvod i baterije sa ovim simbolom ne smeju biti odloženi kao nesortiran kućni otpad. Ako želite da ih se rešite, molimo vas da ne upotrebljavate običnu kantu za đubre. Postoje zasebni sistemi za prikupljanje ovakvih proizvoda.

Naznaka: Hemijski simbol Pb ispod simbola za baterije ukazuje na to da li baterija sadrži olovo.

Contents

Getting Started

Safety Precautions	2
Accessories/Optional Accessories	11
Check the Accessories	11
Optional Accessories	11
Main Features	12
Controls and Features	14
Main Unit - Front	14
Main Unit - Bottom	14
Main Unit - Rear	15
Main Unit - Input Terminals	16
Remote Control	17
Loading Batteries into the Remote Control	18
Effective Range of Remote Control Unit	18

Set up

Installing the Projector	19
Precautions during Installation	19
Precautions during Mounting	20
Adjusting the Position	21
Connecting the Projector	22
Connecting to the HDMI Input Terminal (Digital Input)	22
Connecting to the Component Video Input Terminal (Analog Input)	23
Connecting to the PC Input Terminal RS66 RS56	23
Connecting to the LAN Terminal	24
Connecting to the RS-232C Terminal	24
Connecting to the REMOTE Terminal	24
Connecting to the TRIGGER Terminal	25
Connecting the Power Cord (Supplied Accessory)	25

Operate

Viewing Videos	26
Adjusting the Projector Screen	28
Adjusting the Lens According to the Projection Position	28
Saving and Retrieving Adjustment Settings	29
Adjusting Image Quality Automatically According to the Viewing Environment RS66 RS56 RS48	31
Setting Screen Correction	32
Adjusting the Screen Size (Aspect)	33
Viewing 3D Movies	34
Installing the 3D SYNCHRO EMITTER	34
Viewing 3D Movies	35
Converting 2D Movies to 3D Movies for Viewing	35
Adjusting 3D Movies	36

Adjust/Set

Selecting an Image Quality According to the Video Type	37
Setting the Picture Mode	37

Setting the Color Profile RS66 RS56 RS48	38
Adjusting Movies for Increased Expressiveness (Multiple Pixel Control) RS66 RS56 RS48	40
Fine-tuning the Image Quality	41
Adjusting the Output Value of the Projected Image (Gamma)	41
Adjusting to the Preferred Gamma Setting (Custom Gamma)	43
Compensating Highlights and Shadows (Dark/Bright Level)	44
Adjusting to the Preferred Color (Color Management)	45
Reducing the After-image of Fast-moving Images (Clear Motion Drive (C.M.D.))	46
Adjustments and Settings in the Menu	47
List of Menu Items	47
Picture Adjust	49
Input Signal	53
Installation	55
Display Setup	61
Function	62
Information	64

Maintenance

Replacing the Lamp	65
Lamp Replacement Procedure	65
Resetting the Lamp Time	67
Maintaining the Cabinet and Remote Control	67
Cleaning and Replacing the Filter	68

Troubleshooting

Troubleshooting	69
When the following messages appear... ..	71

Others

External Control	72
RS-232C Specifications	72
TCP/IP Connection	72
Command Format	73
Remote Control Code	74
Communications Example	75
Specifications	76
Index	84

Symbols used in this manual

RS66 indicates a function that is supported by DLA-RS66.

RS56 indicates a function that is supported by DLA-RS56.

RS48 indicates a function that is supported by DLA-RS48.

RS46 indicates a function that is supported by DLA-RS46.

Items not marked with any of the above symbols are supported by all models.

Accessories/Optional Accessories

Check the Accessories

Lens cover **RS48 RS46** 1 piece

†It is attached to the main unit at the time of shipment.

Remote control 1 piece

AAA-size batteries (for operational check) 2 pieces

Power cord (for USA) (about. 2 m) 1 piece

Power cord (for UK) (about. 2 m) 1 piece

Power cord (for EU) (about. 2 m) 1 piece

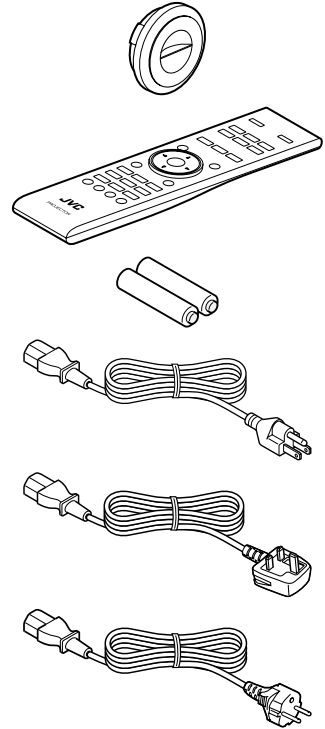

- INSTRUCTIONS (this book), warranty card, and other printed material are also included.

Optional Accessories

- Replacement lamp model: PK-L2312U
- 3D GLASSES models: PK-AG2, PK-AG3
- 3D SYNCHRO EMITTER: models PK-EM1, PK-EM2

Compatibility Chart for 3D SYNCHRO EMITTER and 3D GLASSES

		3D GLASSES		
		PK-AG1 * (Communication Method: IR (Infrared))	PK-AG2 (Communication Method: IR (Infrared))	PK-AG3 (Communication Method: RF (Radio frequency))
3D SYNCHRO EMITTER	PK-EM1 (Communication Method: IR (Infrared))	○	○	—
	PK-EM2 (Communication Method: RF (Radio frequency))	—	—	○

* Discontinued product

Please check with your authorized dealer for details.

Main Features

High-definition 4K display that surpasses full HD quality **RS66** **RS56** **RS48**

The optical engine equipped with a new e-shift2 device has achieved a resolution of 4K.

With JVC's newly-developed image-processing algorithm, you can now enjoy the enhanced expressiveness of the 4K quality. (p. 40)



Delivers a clearer expression with the jaggedness and blurriness of the oblique lines reduced

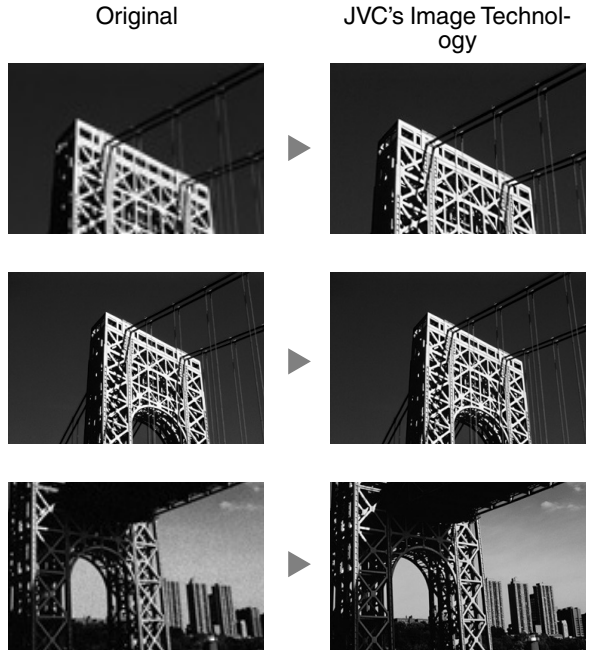

Contrast is enhanced even for the details for them to be reproduced realistically

Noise is reduced to produce vivid and crisp images

The photos are for illustrative purposes only.

3D video expressions with a highly realistic feel **RS66** **RS56** **RS48** **RS46**

With the 3D feature, you can enjoy 3D movies with a more realistic effect. (p. 34)

With the 2D-3D conversion feature, you can now enjoy 3D movies by converting 2D videos of TV programs or those that are recorded using a home video camera into 3D ones. (p. 35)



The photos are for illustrative purposes only.

Optimal image quality adjustment according to the viewing environment **RS66** **RS56** **RS48**

Halation that occurs in environments such as a living room with white walls is taken into consideration for optimal viewing. (p. 31)

- For **RS66** **RS56**, you can utilize the optional optical sensor and dedicated software to make finer adjustments.

For more details, please refer to our website.

<http://www3.jvckenwood.com/projector/support/index.html>



Flexible installation RS66 RS56 RS48 RS46

In addition to the 2x motorized zoom & focus lens, the wide coverage of the lens shift functions also makes installation of the projector more flexible. (p. 28)

The lens memory feature, which enables focus, zoom, or shift settings to be saved or retrieved, enables you to switch to different video size formats easily.

Customizable image quality adjustment feature RS66 RS56 RS48 RS46

You can make adjustments according to the type of video images or your preferences to enjoy the videos in optimal quality. (p. 37)

RS66 RS56 RS48 adopts the Real Color Imaging Technology (a color reproduction technology developed by JVC) to enable reproduction in an image quality that is closer to the original image. (p. 38)



The photos are for illustrative purposes only.

Clear video expression with little after-image (C.M.D.) RS66 RS56 RS48 RS46

By employing the high-definition image interpolation technology developed by JVC, you can enjoy videos with fast movements, such as sports, in a sharp quality. (p. 46)

* C.M.D. is the abbreviation for Clear Motion Drive.

Sharp depiction of details with minimal blur

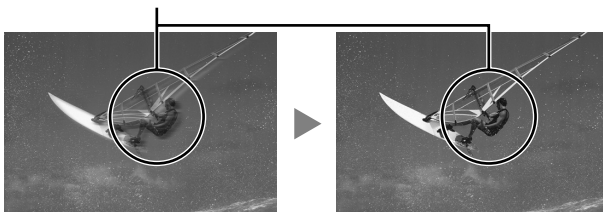

The photos are for illustrative purposes only.

High-precision pixel adjustment feature RS66 RS56 RS48 RS46

With the highly-precise "Pixel Adjust" feature, you can enjoy a clear video quality with little color fringing throughout the entire image.

(p. 55 RS46)(p. 56 RS66 RS56 RS48)

* The accuracy level that can be adjusted varies according to the model.

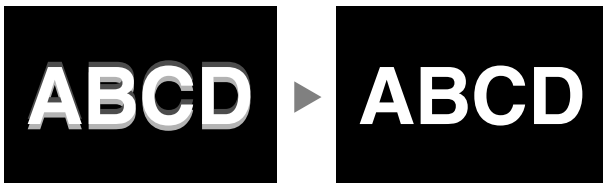

Before adjustment

After adjustment

The photos are for illustrative purposes only.

THX certification RS66 RS56

For RS66 RS56, a "THX 3D Display Certification" by THX has been obtained.

In addition to 2D movies, you can also enjoy faithful reproduction of images in a "quality as intended by the filmmaker" during playback of 3D movies.

The THX 3D certification is "an indication of high definition and high resolution", which is granted to products that have cleared more than 400 image quality tests.

Controls and Features

Main Unit - Front

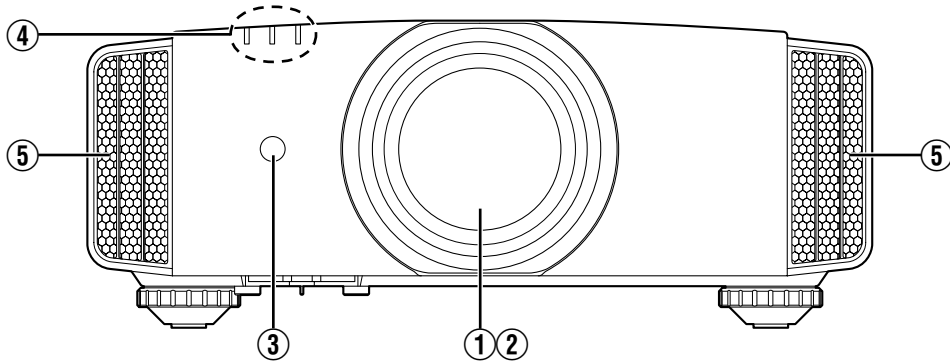

① Lens

This is a projection lens. Do not look through the lens while an image is projected.

② Lens cover **RS66** **RS56**

The lens cover opens/closes when the power supply is turned on/off. (p. 55)

- For **RS48** **RS46**, attach the lens cover when the unit is not in use.

③ Remote Sensor (front)

Please aim the remote control at this area when using it.

- * There is also a remote sensor at the rear.

④ Indicator

Refer to “Indicator Display on the Main Unit” (p. 81).

⑤ Exhaust vent

Warm air is discharged to cool down the internal temperature.
Do not block the vents.

Main Unit - Bottom

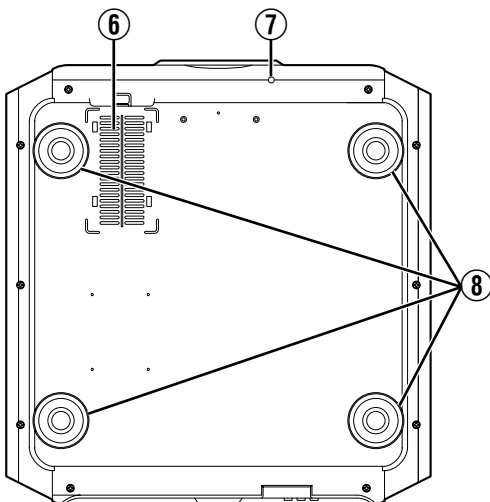

⑥ Inlets (at 3 points on the rear/bottom)

The inlets take in air to cool down the internal temperature.
Do not block or prevent the outflow of hot air. Doing so may cause the unit to malfunction.

- * There are two inlets on the right and left sides at the rear of the unit.

⑦ Manual button for lens cover **RS66** **RS56**

The lens cover can be opened when pressed down.
It is used for maintenance purposes. You can also make use of it when you need to open the lens cover urgently.

⑧ Feet

The height and angle of the projector can be adjusted by turning the foot. (0 to 5 mm) (p. 21)

When the foot is removed, it can be used as the mounting holes for the ceiling mount bracket.

Main Unit - Rear

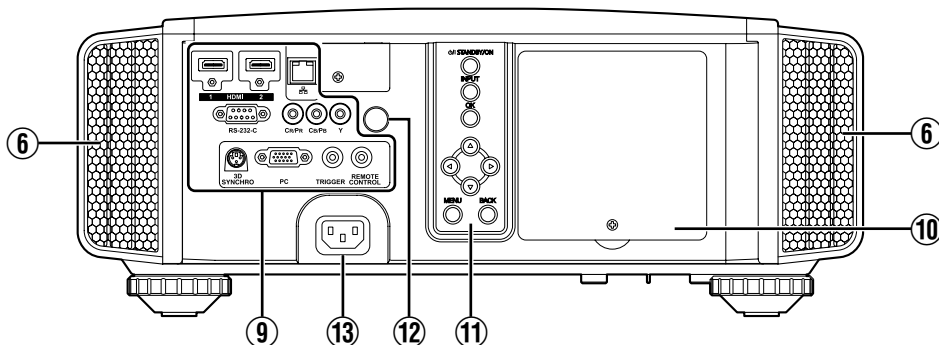

⑨ Input terminals

In addition to the video input terminal, there are also other connection terminals for devices such as controllers and optional equipment. **RS66** **RS56** are used in the illustration.

Please see “Main Unit - Input Terminals” p. 16 for more details about the terminals and **RS48** **RS46**.

⑩ Lamp cover

When replacing the light source lamp, remove this cover.

⑪ Operation panel

For more details, please refer to the “Operation panel” in the diagram below.

Operation panel

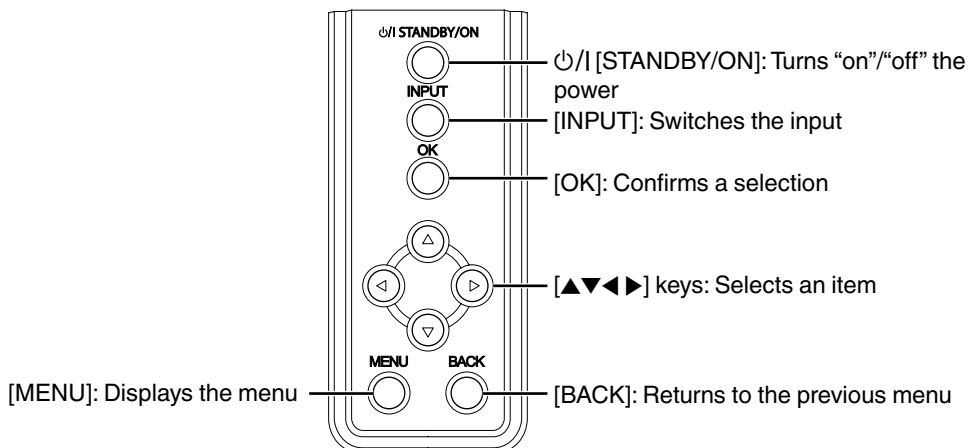

⑫ Remote Sensor (rear)

Please aim the remote control at this area when using it.

* There is also a remote sensor at the front.

⑬ Power input terminal

Connect the supplied power cord to this terminal.

Main Unit - Input Terminals

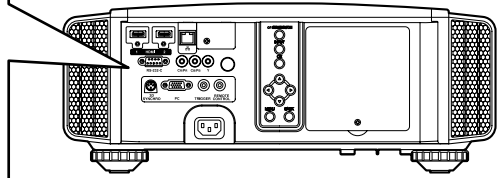
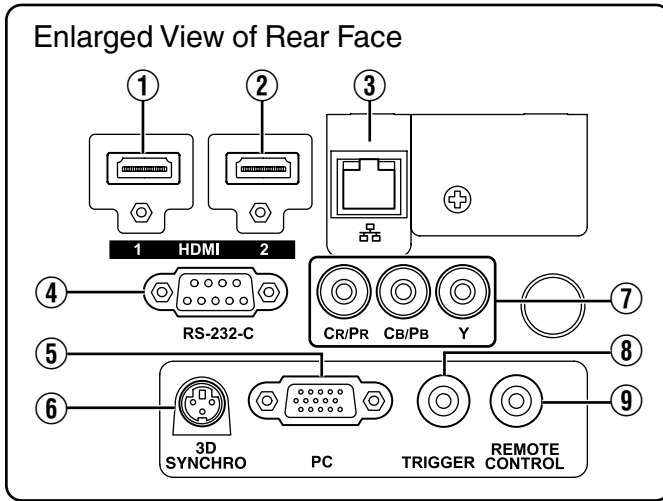

① [HDMI 1] input terminal

② [HDMI 2] input terminal

For connecting to devices that support HDMI output. (p. 22)

It is fitted to the M3 lock hole. The depth of the screw hole is 3 mm.

③ [LAN] terminal (RJ-45)

The projector can be controlled by connecting it to a PC through the computer network for control commands to be sent to the projector.

④ [RS-232C] terminal (D-sub 9-pin male)

The projector can be controlled by connecting a PC to this terminal.

* The LAN and RS-232C terminals cannot be used at the same time. (p. 62)

⑤ [PC] Input terminal (D-sub 15-pin)

RS66 RS56

This is an input terminal used for PC signals (RGB video signals and sync signals) only. It can be connected to a PC monitor output terminal, etc.

⑥ [3D SYNCHRO] terminal

By connecting a 3D SYNCHRO EMITTER (sold separately) to this terminal, you can view 3D movies.

⑦ Component video input terminals (RCA x 3)

For connecting to devices that support component signal output.

It can be used as an input terminal for analog RGB (G on Sync), component (Y, Cb, Cr), or DTV format (Y, Pb, Pr) signals.

⑧ [TRIGGER] terminal (⊖ ⊕)

Output terminal for DC 12V, 100 mA power supply. It is used for sending output signals to control elevating screens for which the use of a SCREEN TRIGGER is supported.

Note that improper connection may damage the projector. (Tip=DC +12 V, Sleeve=GND)

⑨ [REMOTE] terminal (stereo mini jack)

Use this terminal when a remote control unit is not usable, such as when the projector is installed in a dedicated box or for rear projection.

Connect an external remote sensor unit to the projector unit.

For details on the external infrared sensor and connecting cable, please contact your dealer.

Remote Control

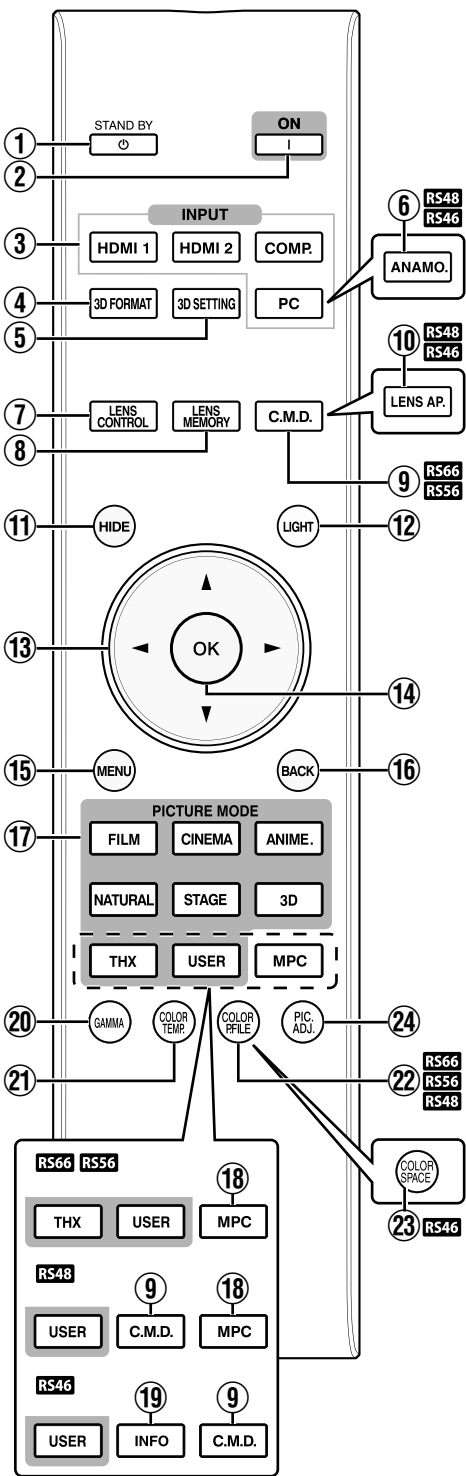

- 1** **[STAND BY]**
Turns off the power. (p. 27)
- 2** **[ON]**
Turns on the power. (p. 26)
- 3** **[INPUT]**
Select an input from [HDMI 1], [HDMI 2], [COMP.], and [PC] (RS66 RS56 only). (p. 26)
- 4** **[3D FORMAT]**
Switches the 3D format. (p. 35)
- 5** **[3D SETTING]**
Displays the 3D setting menu. (p. 35)
- 6** **[ANAMO.]** RS48 RS46
Switches the anamorphic mode. (p. 57)
- 7** **[LENS CONTROL]**
For adjusting focus, zoom, and shift. (p. 28)
- 8** **[LENS MEMORY]**
Switches between saving, retrieving, and editing of the lens memory. (p. 29)
- 9** **[C.M.D.]**
For setting frame interpolation. (p. 46)
- 10** **[LENS AP.]** RS48 RS46
For setting the lens aperture. (p. 52)
- 11** **[HIDE]**
Hides the image temporarily. (p. 26)
- 12** **[LIGHT]**
Illuminates the buttons on the remote control.
- 13** **[▲▼◀▶]** keys
For selecting an item.
- 14** **[OK]**
Confirms a selected item.
- 15** **[MENU]**
Displays the menu, or hides the menu if it is displayed.
- 16** **[BACK]**
Returns to the previous menu.
- 17** **[PICTURE MODE]**
Switches the Picture mode to [FILM], [CINEMA], [ANIME], [NATURAL], [STAGE], [3D], [THX] (RS66 RS56 only), or [USER]. (p. 37)
- 18** **[MPC]** RS66 RS56
For setting the MPC level. (p. 40)
- 19** **[INFO]** RS46
Displays the information menu. (p. 64)
- 20** **[GAMMA]**
For setting the gamma level. (p. 41)
- 21** **[COLOR TEMP]**
For setting the color temperature. (p. 49)
- 22** **[COLOR P.FILE]** RS66 RS56 RS48
Switches the color profile. (p. 38)
- 23** **[COLOR SPACE]** RS46
Switches the color gamut. (p. 51)
- 24** **[PIC. ADJ.]**
Switches the items for adjusting the image quality, such as contrast, brightness, etc. (p. 50)

Loading Batteries into the Remote Control

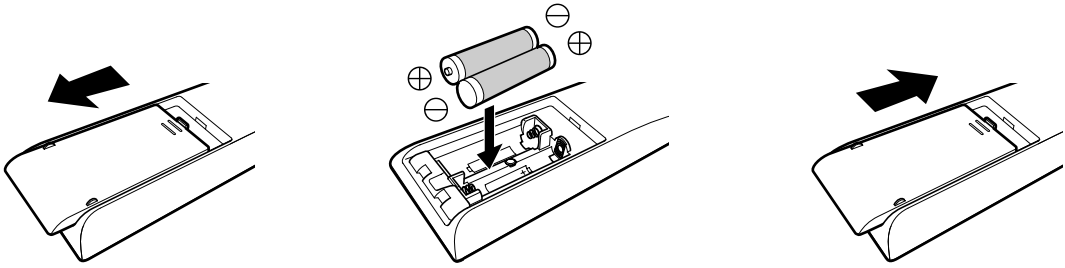

- If the remote control has to be brought closer to the projector to operate, it means that the batteries are wearing out. Replace the batteries with new ones (AAA).
- Insert the batteries according to the \oplus \ominus marks. Be sure to insert the \ominus end first.
- If an error occurs while using the remote control, remove the batteries and wait for five minutes. Load the batteries again and operate the remote control.

Effective Range of Remote Control Unit

When aiming the remote control toward the sensor on this unit (front or rear), ensure that the distance to the sensor is within 7 m.

If the remote control fails to work properly, move closer to this unit.

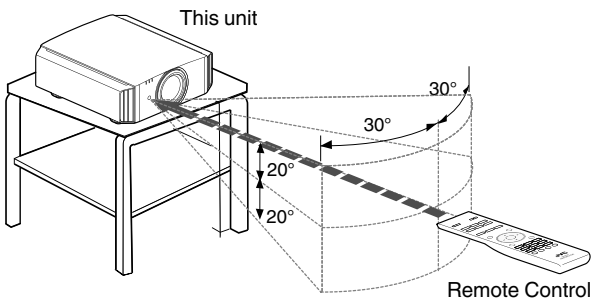

Control through reflection off a screen, etc.

Ensure that the total of distance A (between this unit and the screen) and distance B (between the remote control and the screen) is within 7 m.

* As the efficiency of signals reflected from the remote control unit varies with the type of screen used, the operable distance may decrease.

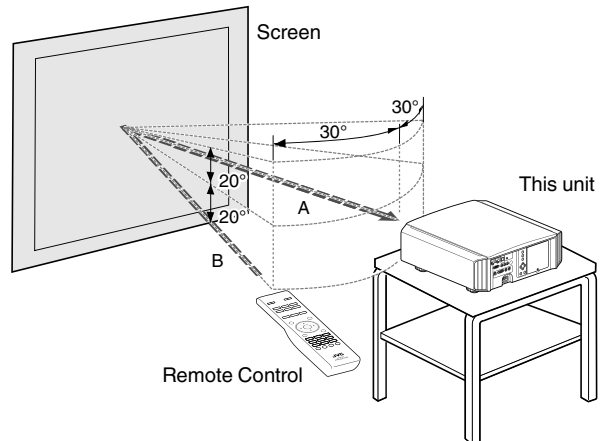

CAUTION

- Do not put the remote control in a place with an exposure to direct sun light or high temperature.

Installing the Projector

Precautions during Installation

Please read the following carefully before installing this unit.

Do not install at the following

This unit is a precision device. Please refrain from installing or using it at the following locations. Otherwise, it may cause fire or malfunction.

- Dusty, wet and humid places
 - Places subject to oily smoke or cigarette smoke
 - On top of a carpet or bedding, or other soft surfaces
 - Places exposed to direct sunlight
 - Places with a high or low temperature
 - Do not install this unit in a room that is oily or subject to cigarette smoke. Even a small quantity of smoke or oiliness can have a long-term impact on this unit.
- * This unit produces a great amount of heat, and is designed to take in cool air to cool its optical components. Using the unit at the above locations may cause dirt to attach to the light path, thereby resulting in dark images or dull colors.
- * Dirt that sticks to the optical components cannot be removed.

Maintain clearance from the wall, etc.

As the unit discharges a large amount of heat, install it with adequate clearance from the surroundings as shown below.

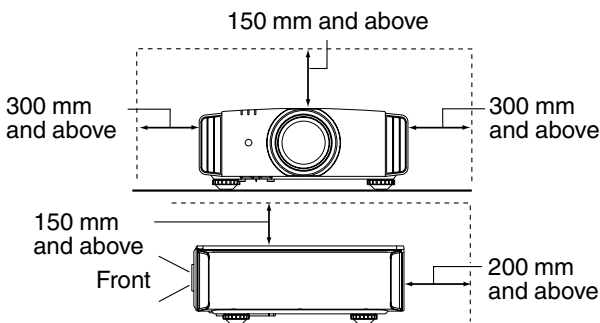

Leave the front area of the unit unblocked. If there is any obstructing object in front of the exhaust vent, hot air will flow back to the unit and cause it to heat up. Hot air flowing out of the unit may cause shadows on the screen (heat haze phenomenon).

Using the projector

This unit uses a projection lamp, which will heat up when in use.

Please refrain from projecting in the following circumstances. Otherwise, it may cause fire or malfunction.

- Projection with the unit stood vertically

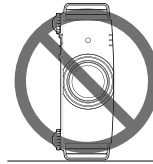

- Projection with the unit inclined at an angle

Horizontal inclination: within $\pm 5^\circ$

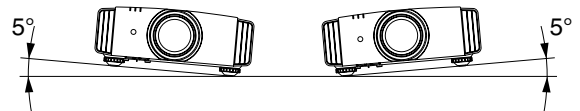

Vertical inclination: within $\pm 15^\circ$

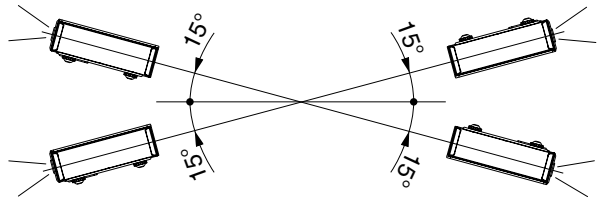

- Malfunction may occur if the angle is not set within the abovementioned range.

Installing the screen

Install the unit and the screen such that they are perpendicular to each other.

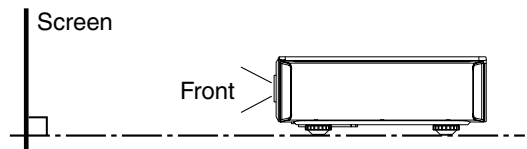

- Please choose a screen material with non-uniform patterns. Uniform patterns such as checks may cause interference patterns to occur.
- In this case, you can change the size of the screen to make the interference patterns less noticeable.

Using the projector at a high altitude

When using this unit at a location that is higher than 900 m above sea level (low air pressure), set the "High Altitude Mode" to "On". (p. 62)

Precautions during Mounting

Securing (mounting) the projector

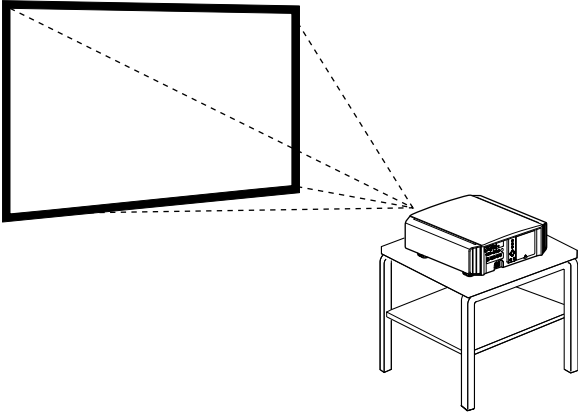

- When this unit is to be mounted to a fixed position for use, install it horizontally.
- Make sure to secure the main unit to prevent accidents such as during an earthquake.

Securing the projector (ceiling mount)

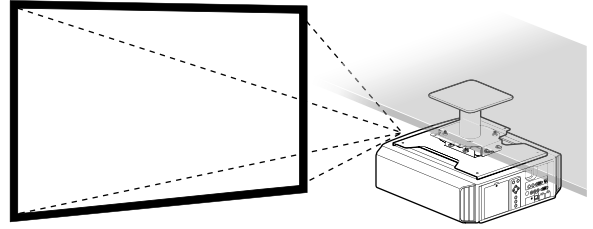

- Special expertise and techniques are required for mounting this unit to the ceiling. Make sure that you get the authorized dealer or a specialist to install it.
- Take the necessary actions to prevent the main unit from falling off such as during an earthquake.
- Regardless of the warranty period, JVC is not liable for any product damage caused by mounting the unit with non-JVC ceiling fittings or to an environment that is not suited for ceiling mount.
- When using the unit with it suspended from a ceiling, pay attention to the surrounding temperature. When a heater is in use, the temperature around the ceiling may be higher than expected.

Securing with screws

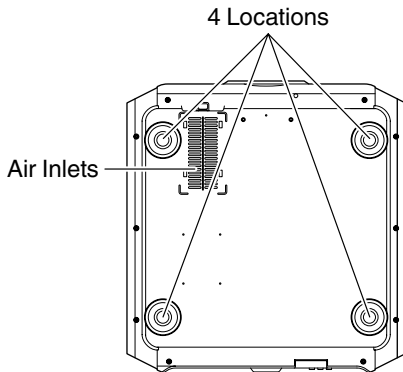

Remove the four feet at the bottom, and fasten using the screws (M5 screws, 13 to 23 mm).

- * Using screws other than those designated may cause the unit to break down.
- * Leave a clearance of at least 10 mm from the bottom surface of the unit to allow it to take in cool air.

Adjusting the Position

Adjusting the elevation angle of the projector

The height and inclination of the unit (0 to 5 mm) can be adjusted by turning the feet.

Lift the unit and adjust the four feet.

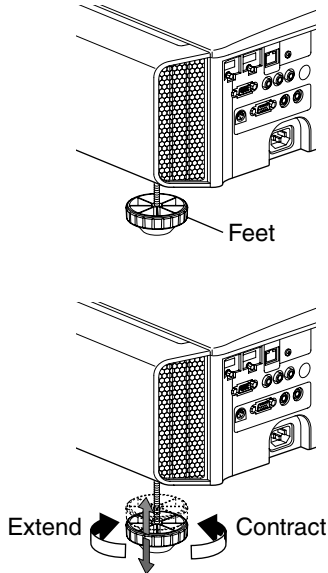

Adjusting the position of the image

By using the lens shift feature of this unit, you can shift the image upward/downward or to the left/right. Set it to your preferred position.

■ Horizontal Position

Vertical Position: 0% (Center)

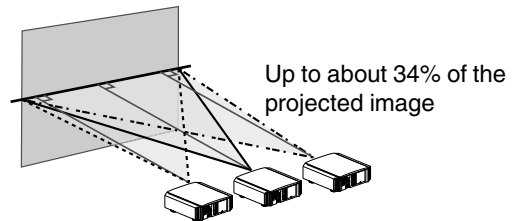

■ Vertical Position

Horizontal Position: 0% (Center)

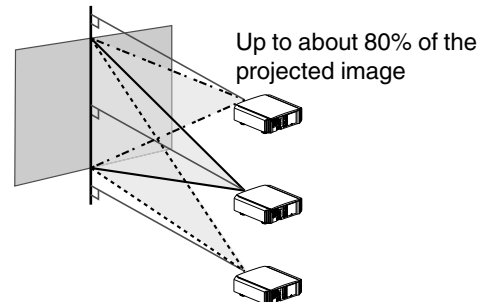

■ Lens shift Range

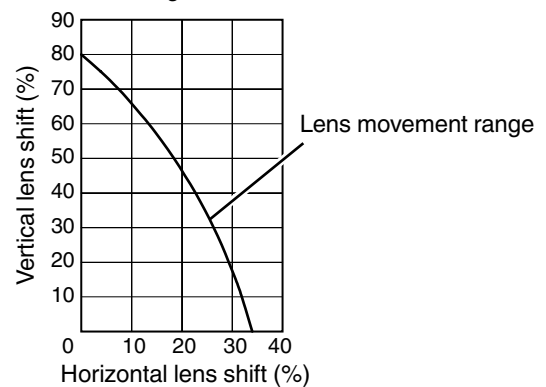

- The maximum vertical shift varies with the amount of horizontal shift. Similarly, the maximum horizontal shift also changes with the amount of vertical shift.
- The values on the graph are intended as a guide. Use them for reference during installation.

Connecting the Projector

- Do not turn on the power until connection is complete.
- The connection procedures differ according to the device used. For details, please refer to the instruction manual of the device to be connected.
- This projector is used for projecting images. To output the audio of connected devices, please connect a separate audio output device, such as an amplifier or speaker.
- The images may not be displayed depending on the devices and cables to be connected. Use only HDMI cables (sold separately) that are HDMI-certified.
- Some cables cannot be connected to this unit due to the size of their connector cover.

Connecting to the HDMI Input Terminal (Digital Input)

Connecting via HDMI cable

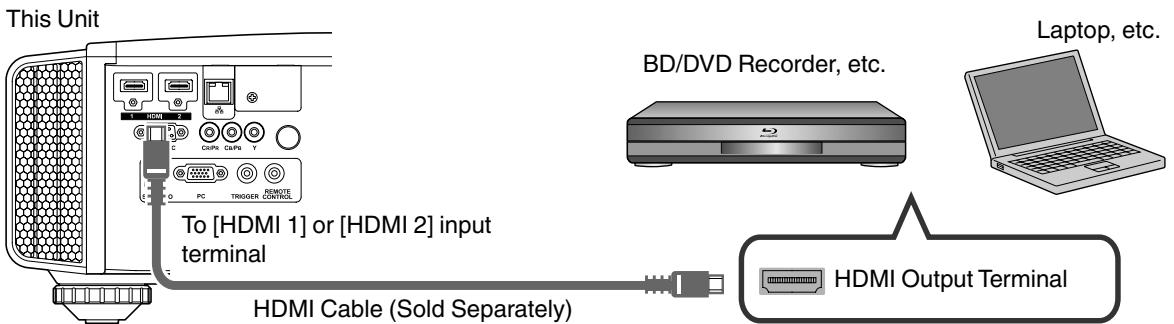

- If noise occurs, move the laptop away from this unit.
- For a transmission bandwidth in compliance with the HDMI standard, a 340 MHz cable is recommended. When using a cable with a bandwidth of 75 MHz, you are recommended to set the resolution of the equipment transmitting the video to 1080i or lower.
- If the video is not displayed, try to reduce the length of the cable or lower the resolution of the video transmitting equipment.

Connecting via HDMI-DVI conversion cable

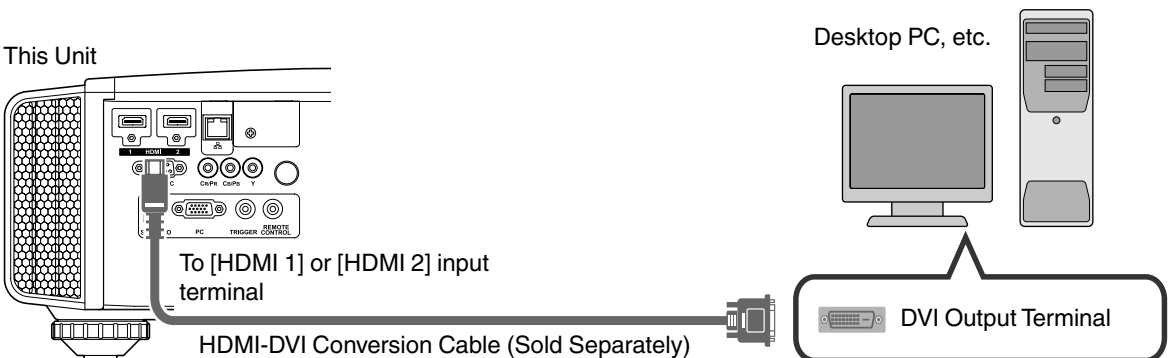

- If noise occurs, move the desktop PC away from this unit.
- If the video is not displayed, try to reduce the length of the cable or lower the resolution of the video transmitting equipment.

Connecting to the Component Video Input Terminal (Analog Input)

Connecting via component video cable

This Unit

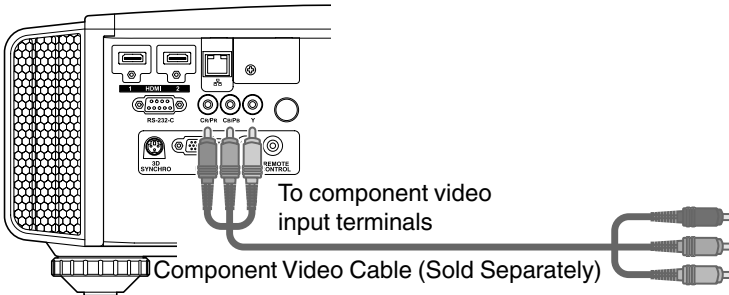

BD/DVD Recorder, etc.

Component Video Output Terminals

● C_R / P_R (Red)

● C_B / P_B (Blue)

● Y (Green)

- Set "COMP." to "Y Pb/Cb Pr/Cr" in the setting menu. (p. 53)

Set up

Connecting via RGB video cable

This Unit

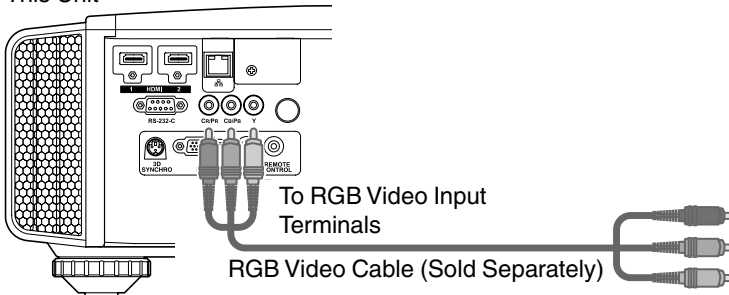

Device Equipped with RGB Output, etc.

RGB Video Output Terminals

● R (Red)

● B (Blue)

● G (Green) (Includes Sync Signal)

- Set "COMP." to "RGB" in the setting menu. (p. 53)
- For more information on compatible input signals, please refer to "Specifications" p. 76.

Connecting to the PC Input Terminal **RS66** **RS56**

This Unit

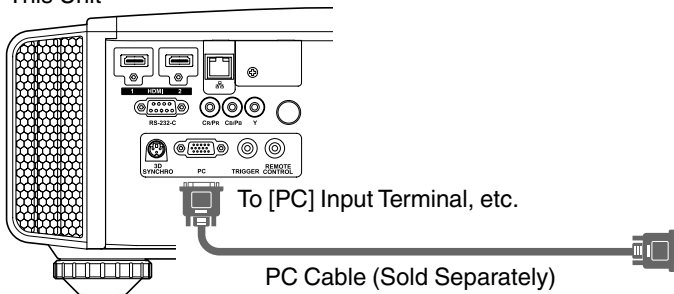

Laptop, etc.

VGA Output Terminal

- For more information on compatible signals, please refer to "Types of Possible Input Signals" (p. 79).

Connecting to the LAN Terminal

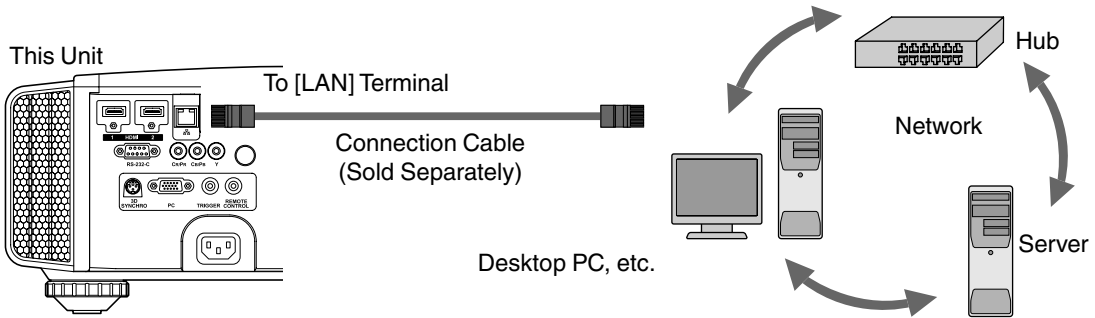

- The network is used to control this unit. It is not used for sending or receiving video signals.
- Please contact your network administrator for information concerning the network connection.
- Set "ECO Mode" to "Off" if RS-232C/LAN communication is performed or the HDMI link function is used in the Standby mode. (p. 62)
- For more information on control, please refer to "External Control" (p. 72).

Connecting to the RS-232C Terminal

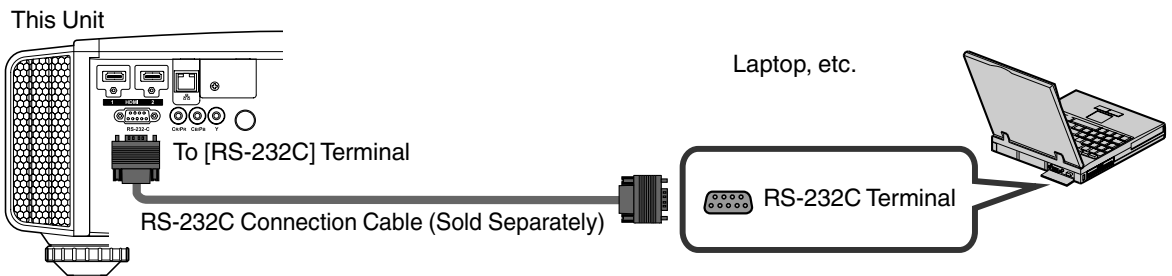

- Set "ECO Mode" to "Off" if RS-232C/LAN communication is performed or the HDMI link function is used in the Standby mode. (p. 62)
- For more information on control, please refer to "External Control" (p. 72).

Connecting to the REMOTE Terminal

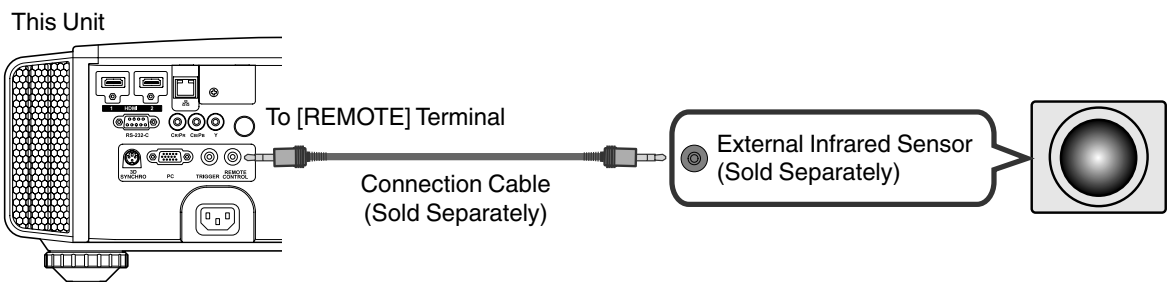

- For more information on the external infrared sensor and connecting cable, please contact your dealer.

Connecting to the TRIGGER Terminal

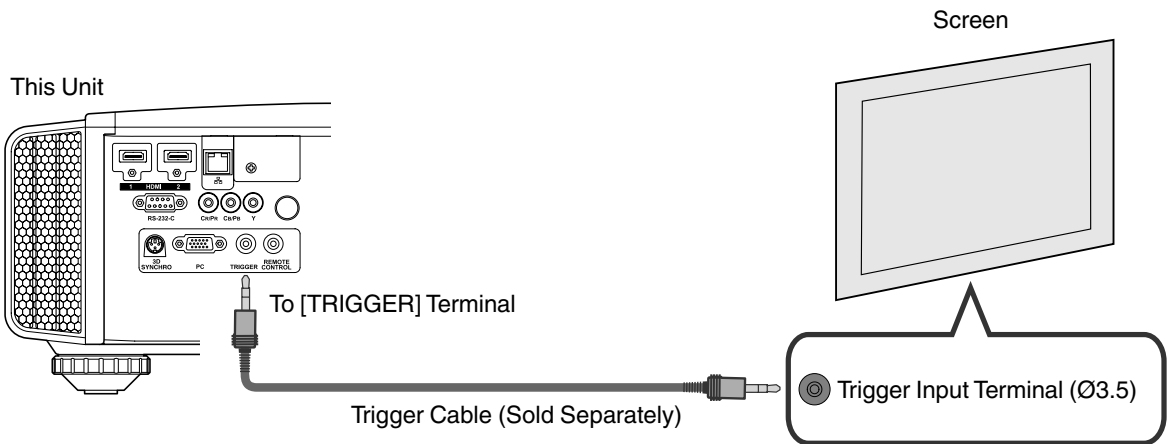

- Do not use it to supply power to other devices.
- Connecting to the audio terminal of another device may cause the device to malfunction or break down.
- Using beyond the rated value will cause the unit to malfunction.
- The trigger terminal outputs a voltage of 12 V. Exercise adequate caution to prevent short circuit.
- The factory setting is “Off”. To change the setting, configure the “Trigger” item in the menu (p. 62).

Connecting the Power Cord (Supplied Accessory)

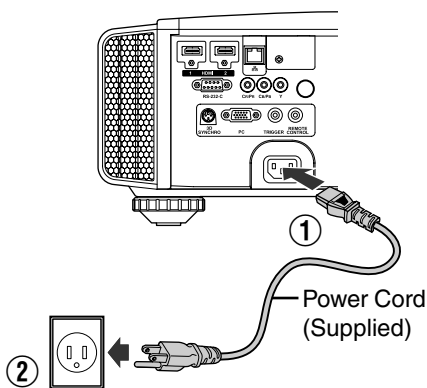

- ① Connect the power cord supplied to the power input terminal on the main unit
- ② Insert the supplied power plug into the wall outlet.

Precautions to prevent fire and electric shock

- The voltage capacity of this unit is large. Please connect it directly to the wall outlet.
- When you are not using the equipment, please unplug the power cord from the outlet.
- Connect it using only the power cord supplied.
- Do not use a voltage other than the indicated power voltage.
- Do not damage, break or modify the power cord. Do not place a heavy object on the power cord, or heat or pull it. Doing so may damage the power cord.
- Do not unplug the power cord with wet hands.

Viewing Videos

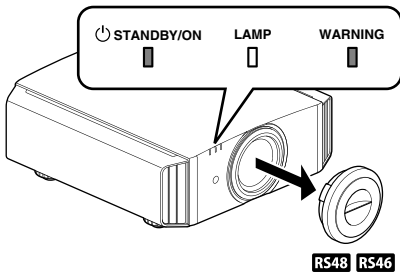

MEMO

- When you are using **RS48 RS46**, be sure to remove the lens cover.
- Connect the power cord, and ensure that the “STANDBY/ON” indicator lights up in red.

1 Turn on the power

Remote control: press the **I** [ON] button

Projector unit: press the **⏻** [STANDBY/ON] button

- The “STANDBY/ON” indicator light switches from red to green (light goes off after the unit starts up).
- (**RS66 RS56**) The motorized lens cover opens.

“STANDBY/ON” lights up (red)
In standby state

“STANDBY/ON” lights up (green)
During lamp startup

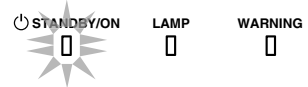
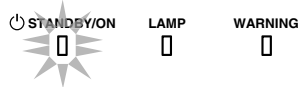

2 Choose the image to project

Remote control: press the [INPUT] button ([HDMI 1], [HDMI 2], [COMP.], [PC] (**RS66 RS56** only))

Projector unit: press the [INPUT] button (pressing the button each time switches the mode)

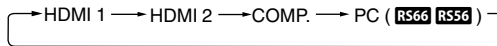

- Play back the selected device to project the image.

To hide the image temporarily

Press the [HIDE] button on the projector unit or remote control

- The “STANDBY/ON” indicator light starts to blink in green.
- Press the [HIDE] button again to resume display of the image.
- The power cannot be turned off when the image is temporarily hidden.

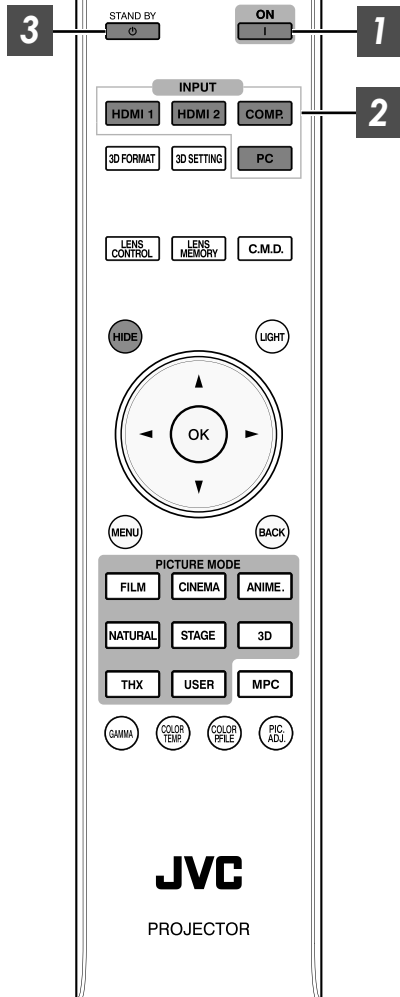

3 Turn off the power

Remote control: press the  [STAND BY] button

Projector unit: press the /I [STANDBY/ON] button

- While the “Are you sure you want to turn off?” message is displayed, press the button again.
- The lamp turns off, and the “STANDBY/ON” indicator switches from a green light to a red blinking light.
- After the light goes off, the fan will run for about 60 seconds to cool down the lamp (Cool-down mode)
Do not disconnect the power cable while cooling is in progress.
- After about 60 seconds, the “STANDBY/ON” indicator switches from a blinking red to a solid red light.

“STANDBY/ON” blinking (red)
In the Cool-down mode

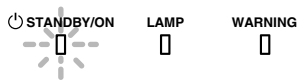

“STANDBY/ON” lights up (red)
In standby state

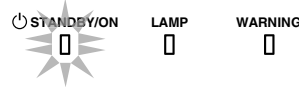

- **(RS48 RS46)** Attach the lens cover.
- **(RS66 RS56)** The motorized lens cover closes.

CAUTION

- The power cannot be turned off within approximately 90 seconds after it has been turned on.
- After the light goes off, the fan will run for about 60 seconds to cool down the lamp (Cool-down mode)
Do not disconnect the power cable while cooling is in progress.
- The power cannot be turned on again while cooling is in progress (60 seconds).
- Pull out the power plug when the unit is not to be used for a prolonged period of time.

Adjusting the Projector Screen

Adjusting the Lens According to the Projection Position

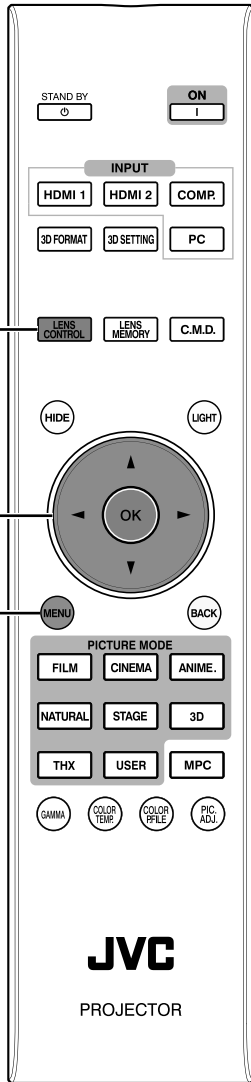

1 Press the [LENS CONTROL] button, and use the [▲▼◀▶] keys to adjust Focus, Zoom (screen size), and Shift (screen position)

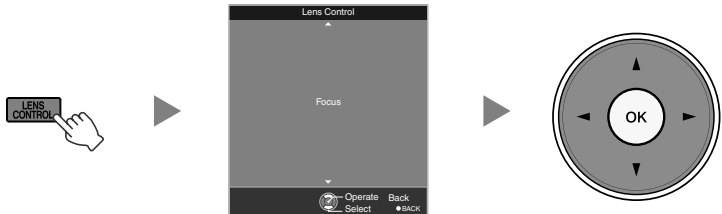

- Pressing the [LENS CONTROL] or [OK] button each time switches the mode in the following sequence: “Focus”→“Zoom”→“Shift”→“Focus”...

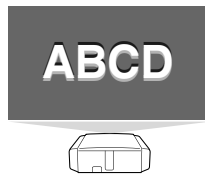

Focus Adjustment

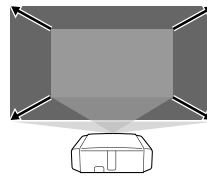

Zoom (Screen Size) Adjustment

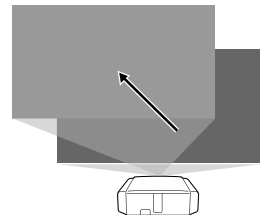

Shift (Screen Position) Adjustment

2 Press the [BACK] button once, or the [MENU] twice, to end adjustment.

Saving and Retrieving Adjustment Settings

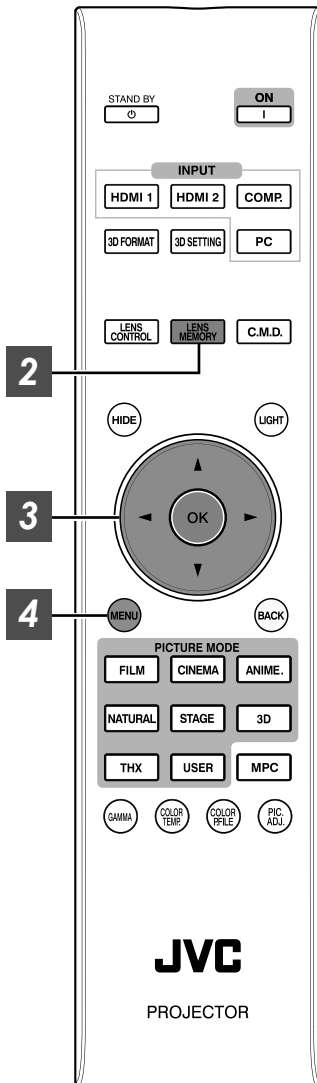

The focus, zoom, and shift settings can be saved or retrieved, so you can switch easily to a different aspect ratio (screen size) according to the image.

- Pressing the [LENS MEMORY] button each time switches the mode in the following sequence: “Lens Memory Save”→“Lens Memory Select”→“Lens Memory Name Edit”→“Lens Memory Save”...
- In a state where no adjustment settings are saved (factory default), only “Lens Memory Save” is displayed.

Saving an adjustment data

- 1 Adjust focus, zoom, or shift (p. 28)
- 2 Press the [LENS MEMORY] button to display “Lens Memory Save”

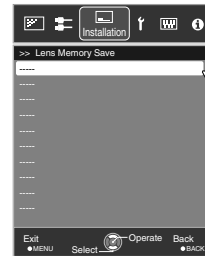
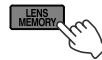

- You can also save an adjustment data by selecting “Installation” →“Lens Control”→“Lens Memory Save” from the menu.

- 3 Select the item to save, and press the [OK] button
 - The adjustment data is saved.
 - Items with no adjustment data saved are displayed as [----].
 - If you have selected an item for which an adjustment data has already been saved, the old data will be overwritten.
 - You can change the name when saving an item. (p. 30)
 - The maximum number of items can be saved is 10 for **RS66** **RS56** and 5 for **RS48** **RS46**.

- 4 Press the [MENU] button to exit

Retrieving an adjustment data

1 Press the [LENS MEMORY] button to display “Lens Memory Select”

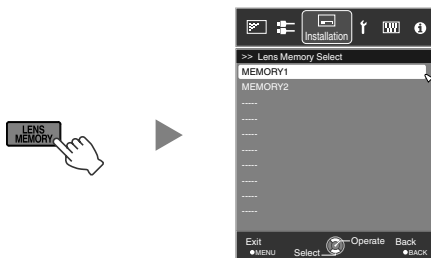

- You can also retrieve an adjustment data by selecting “Installation”→“Lens Control”→“Lens Memory Select” from the menu.

2 Select the adjustment data to retrieve, and press the [OK] button

- The retrieved data is adjusted automatically.
- If no adjustment data has been saved, the item will be grayed out and cannot be selected.

Renaming an adjustment data

1 Press the [LENS MEMORY] button to display “Lens Memory Name Edit”

- You can also edit an adjustment data by selecting “Installation”→“Lens Control”→“Lens Memory Name Edit” from the menu.

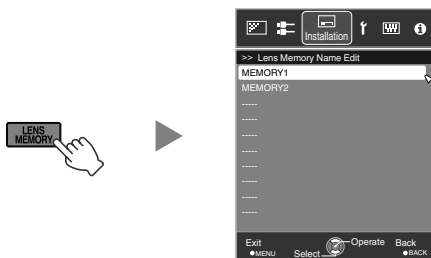

2 Select the adjustment data to edit, and press the [OK] button

- An edit screen appears.

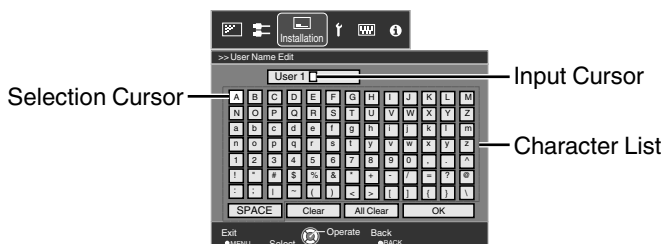

- You can input up to 10 characters.
- Characters that are usable include alphabets (upper or lower case), numeric characters, and symbols.
- Pressing the [Back] button cancels the content that is currently being edited, and exits the edit mode.

3 After renaming, select “OK” and press the [OK] button

4 Press the [MENU] button to exit

Adjusting Image Quality Automatically According to the Viewing Environment **RS66 RS56 RS48**

By configuring “Environment Setting” according to the viewing environment, image quality adjustment and correction according to environmental differences are performed automatically to minimize any influence on the image quality.

- “Environment Setting” is applied separately from the individual image adjustment settings (p. 49).

- Front View -

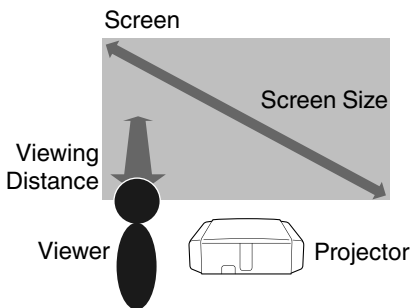

1 Press the [MENU] button to display the menu

2 Select “Installation”→“Environment Setting”→“On” from the menu

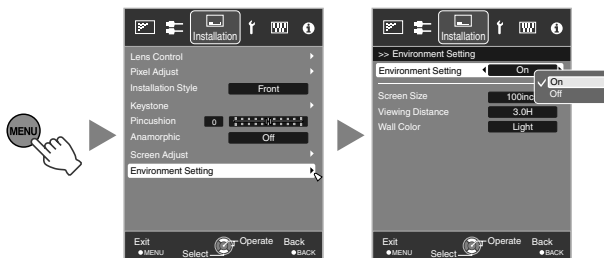

- When “Environment Setting” is set to “Off”, “Screen Size”, “Viewing Distance”, and “Wall Color” are grayed out and cannot be selected.

3 Select “Screen Size” to configure the screen size to use

- Select the closest screen size setting from the range between “60inch” and “200inch” (in 10-inch increments).

4 Select “Viewing Distance” to configure the viewing distance (distance to the screen)

- Select the closest viewing distance setting from the range between “1 m” and “10 m”.
- For more details on the height, please refer to “Screen Size and Projection Distance”p. 77.

5 Select “Wall Color” to configure the wall color

- If the wall is black in color, select “Dark”. For walls with a color other than black, select “Light”.

6 Press the [MENU] button to exit

MEMO

- For **RS66 RS56**, you can utilize the optional optical sensor and dedicated software to make finer adjustments. For more information on the dedicated software, please visit our website.

<http://www3.jvckenwood.com/english/download/index.html>

Setting Screen Correction

By selecting the optimal correction mode according to the characteristics of the screen in use, corrections can be performed to reproduce natural images with balanced colors.

- For **RS66** **RS56** **RS48**, this function is deactivated when “Color Profile” is set to “Off”.

1 Press the [MENU] button to display the menu

2 Select “Installation”→“Screen Adjust”→“On” from the menu

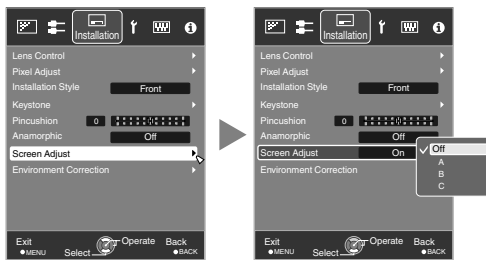

- **RS66** **RS56**: select one from the 105 types (“1” to “105”).
- **RS48** **RS46**: select one from the three types (“A”, “B”, or “C”).
- For information on the screen and the corresponding correction mode, please visit our website.

<http://www3.jvckenwood.com/english/projector/screen/>

3 Press the [MENU] button to exit

Adjusting the Screen Size (Aspect)

The screen size of the projected image can be adjusted optimally according to the original screen size (aspect) that has been input.

1 Press the [MENU] button to display the menu

2 Select “Input Signal”→“Aspect (Video)” or “Aspect (PC)” from the menu

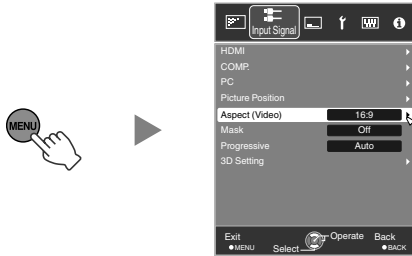

Input Signal	Setting	Description
Aspect (Video)	4:3	Sets the screen size to 4:3. For HD signals, the two sides are reduced.
	16:9	Sets the screen size to 16:9. For SD signals, the two sides are expanded.
	Zoom	Enlarges the entire image. Not selectable in the case of HD signals.
Aspect (PC)	Auto	Positions the image at the center with the entire image enlarged.
	Just	Displays the input image in the actual size.
	Full	Fills the entire screen with the image with the size (aspect) of the input image ignored.

• During 3D signal input, the size is fixed at “16:9”

3 Press the [MENU] button to exit

Example of input image and screen size

HDMI input, component video input

Output Image / Input Image		Setting		
		4:3	16:9	Zoom
4:3				
2.35:1 (Cinema Scope)				

PC Input

Output Image / Input Image		Setting		
		Auto	Just	Full
1280x1024				
1920x1200				

Operate

Viewing 3D Movies

By using the 3D GLASSES (PK-AG1, PK-AG2, or PK-AG3) and 3D SYNCHRO EMITTER (PK-EM1 or PK-EM2), both sold separately, you can enjoy 3D video images.

- For 3D GLASSES and 3D SYNCHRO EMITTER that are compatible with this unit, please refer to “Optional Accessories”p. 11.

Installing the 3D SYNCHRO EMITTER

- 1 Connect 3D SYNCHRO EMITTER to the [3D SYNCHRO] terminal on the main unit

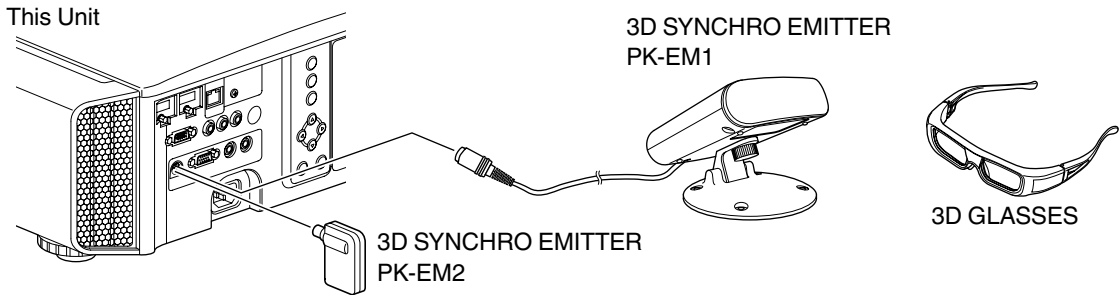

- 2 Adjust the 3D SYNCHRO EMITTER position so that the 3D GLASSES can receive signals from the 3D SYNCHRO EMITTER

- For more details, please refer to the instruction manuals 3D GLASSES and 3D SYNCHRO EMITTER.

Viewing 3D Movies

1 Connect this unit to a 3D-compatible HDMI device, and turn on the power to play back the 3D video image

- For details on how to play back 3D video images, please refer to the instruction manual of the player or recorder in use.
- When 3D signals are received, the video image switches automatically to the 3D format.
- This unit supports the following 3D formats.
 - Frame packing
 - Side-by-side
 - Top-and-bottom
- In the default setting, “3D Format” is set to “Auto” for automatic projection of 3D images.

If the image does not switch to 3D automatically
Press the [3D FORMAT] button on the remote control

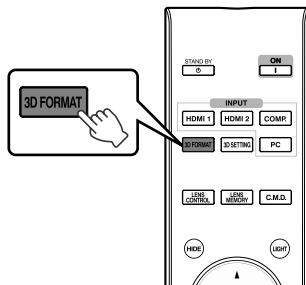

- Pressing the [3D FORMAT] button each time switches the mode in the following sequence: “Auto”→“Side by Side”→“Top and Bottom”→“2D”→“Auto”...

Format	Description
Auto	The format is detected and configured automatically.
Side by Side	Select this setting if the 3D input signal is of the side-by-side format.
Top and Bottom	Select this setting if the 3D input signal is of the top-and-bottom format.
2D	Select this setting if 2D images are falsely recognized as 3D ones.

2 Turn of the power of the 3D GLASSES and put them on

- The PK-AG1 powers on automatically.

Converting 2D Movies to 3D Movies for Viewing

1 Press the [3D SETTING] button to display “3D Setting”

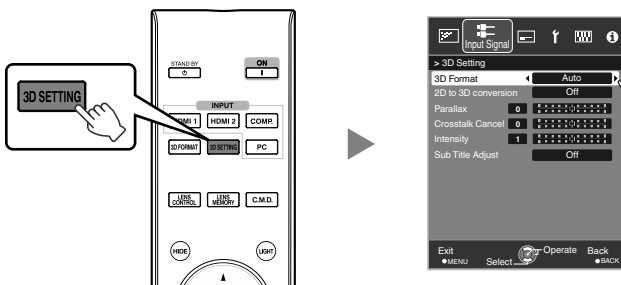

2 Select “2D to 3D conversion” followed by “On”, and press the [OK] button

3 Press the [MENU] button to exit

MEMO

- Depending on the movies, 3D effect may be less than what you expected.

Adjusting 3D Movies

3D video images may appear differently to different viewers. It may also be affected by your physical condition at the time of viewing.

You are therefore recommended to adjust the video images accordingly.

1 Press the [3D SETTING] button to display “3D Setting”

Adjusting parallax (Parallax)

Adjust the displacement of the image for the left and right eyes separately to obtain the best 3D effect.

- To do so, use the ◀▶ keys to move the cursor.
- Setting range: -15 to +15

Adjusting crosstalk (Crosstalk Cancel)

Double images (overlapping of the left image with the one on the right or vice versa) can be reduced to deliver a clear quality.

- To do so, use the ◀▶ keys to move the cursor.
- Setting range: -8 to +8
- * Adjustment cannot be made when “2D to 3D conversion” is set to “On”.

Adjust the depth perception (Intensity)

The depth of the image can be adjusted to deliver the best 3D effect during 2D-3D image conversion.

- To do so, use the ◀▶ keys to move the cursor.
- Setting range: 1 to 5
- * Adjustment can only be made when “2D to 3D conversion” is set to “On”.

MEMO

- Depending on the movies, 3D effect may be less than what you expected.

Adjusting the subtitle display (Sub Title Adjust)

If distortion occurs in the subtitle during 2D-3D image conversion, set to “On”.

- * Adjustment can only be made when “2D to 3D conversion” is set to “On”.

2 Press the [MENU] button to exit

Selecting an Image Quality According to the Video Type

Setting the Picture Mode

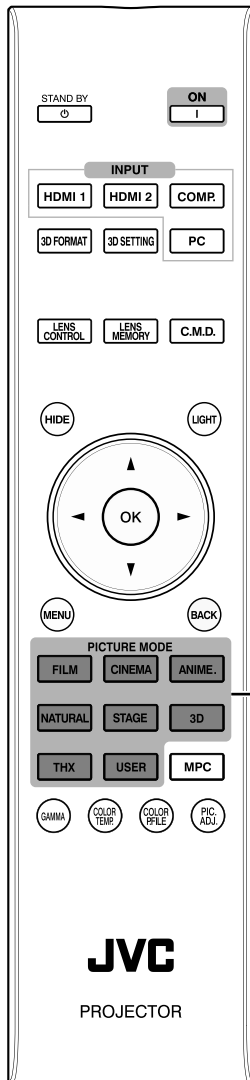

You can adjust the image quality according to the type of video image you are viewing.

1 Press the [PICTURE MODE] button to display “Picture Mode”

2 Select “Picture Mode”

Item	Description
Film	Reproduces the image in a film quality. Suitable for all movies.
Cinema	Reproduces the image in vivid colors based on the DCI* standard. Suitable for digital movies.
Animation	Suitable for animated works.
Natural	Image quality that focuses on natural color and gradation reproduction. Suitable for drama footage, etc.
Stage	Suitable for concerts or theatrical works.
3D	Sharp image quality suitable for 3D works.
THX RS66 RS56	Image quality certified by THX.
User 1 to User 5	Enables user-defined image quality data to be saved and retrieved.

* DCI is the abbreviation for Digital Cinema Initiatives.

Setting the Color Profile **RS66** **RS56** **RS48**

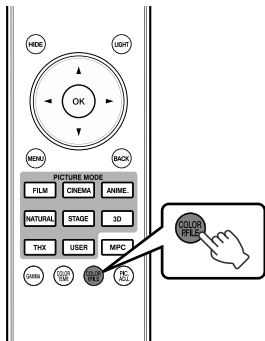

By setting the “Color Profile” (color space information) according to the “Picture Mode”, you can fine-tune the image quality according to the movie you are viewing.

1

After configuring “Picture Mode” (p. 37), press the [COLOR P.FILE] button

- Pressing the [COLOR P.FILE] button each time switches the “Color Profile” data for the “Picture Mode” in sequence.

List of “Color Profile” for “Picture Mode” **RS48**

Picture Mode	Color Profile	Description
Film	Film	Color space that is suitable for all movies.
	Standard	Color space of the HDTV* standard.
Cinema	Cinema	Color space that is suitable for movies with vivid colors.
	Standard	Color space of the HDTV* standard.
Animation	Anime	Color space that is suitable for animated works.
	Standard	Color space of the HDTV* standard.
Natural	Natural	Color space that is suitable for drama footage, etc.
	Standard	Color space of the HDTV* standard.
Stage	Stage	Color space that is suitable for concerts, theatrical performances, etc.
	Standard	Color space of the HDTV* standard.
3D	3D	Color space that is suitable for 3D movies.
	Standard	Color space of the HDTV* standard.
User 1 to User 5	Stage	When “Picture Mode” is set to any of the settings from “User 1” to “User 5”, you can select one of the color profiles shown on the left. <ul style="list-style-type: none"> See above for the description of the respective color profiles.
	Standard	
	Cinema	
	Anime	
	Natural	
	Stage	
	3D	
Off	Disables color space adjustment.	

* HDTV is the abbreviation for High Definition Television.

List of “Color Profile” for “Picture Mode” RS66 RS56

Picture Mode	Color Profile	Description
Film	Film 1	Color space that is close to the characteristics of Eastman Kodak Company movie films.
	Film 2	Color space that is close to the characteristics of FUJIFILM Corporation movie films.
	Film 3	Color space suitable for digitally remastered piece of art based on a Technicolor film.
Cinema	Cinema 1	Color space with rich colors that are characteristic of movies.
	Cinema 2	Color space that is close to that of the DCI standard.
	Standard	Color space of the HDTV*1 standard.
Animation	Anime 1	Color space that is suitable for CG animation works. Ideal for animated works with bright colors.
	Anime 2	Color space that is suitable for cel animation works. Ideal for animated works with light colors.
	Standard	Color space of the HDTV*1 standard.
Natural	Video	Color space that is suitable for TV programs, dramas, sports programs, etc.
	Vivid	Color space with vivid colors. Suitable for games, etc.
	AdobeRGB	Color space of the AdobeRGB*2 standard.
	Standard	Color space of the HDTV*1 standard.
Stage	Stage	Color space that is suitable for concerts, theatrical performances, etc.
	Standard	Color space of the HDTV*1 standard.
3D	3D Cinema	Color space that is suitable for 3D movies.
	3D Video	Color space that is suitable for 3D TV programs, dramas, and sports programs.
	3D Animation	Color space that is suitable for 3D animation works.
THX	THX	Color space of the THX standard.
User 1 to User 5	Standard	When “Picture Mode” is set to any of the settings from “User 1” to “User 5”, you can select one of the color profiles shown on the left. <ul style="list-style-type: none"> • See above for the description of the respective color profiles.
	AdobeRGB	
	Video	
	Vivid	
	Stage	
	Anime 1 / Anime 2	
	Cinema 1 / Cinema 2	
	3D Cinema	
	3D Video	
	3D Animation	
	Off	
	Custom1 to Custom5	Saves the auto calibration values. <ul style="list-style-type: none"> • To perform auto calibration, you need to get ready a commercially available optical sensor and a dedicated software program. For more details, please refer to our website.

*1 HDTV is the abbreviation for High Definition Television.

*2 AdobeRGB is a color space with a wide gamut as defined by Adobe.
 Adobe is a registered trademark or trademark of Adobe Systems Incorporated in the United States and other countries.

Adjusting Movies for Increased Expressiveness (Multiple Pixel Control)

RS66 RS56 RS48

The new image-processing algorithm developed by JVC helps to create a natural impression that is sharper at areas in focus, and softer at areas that are not in focus, enabling you to enjoy highly expressive 4K images with a greater sense of depth.

1 Press the [MPC] button to display the adjustment menu

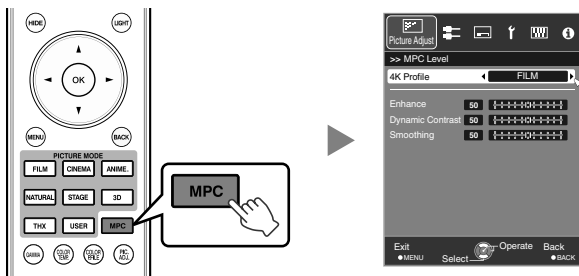

2 Select “4K Profile” and press the [OK] button to select the content type you are viewing

Content Type	Description
FILM	For viewing movies on Blu-ray disc produced using films
High Resolution	For viewing Blu-ray Disc works
HD	For viewing TV broadcasting and recorded works
SD	For viewing DVD works
Dynamic	For enhanced effects
Off	For displaying in the original resolution (2K)

- * HD is the abbreviation for High Definition.
- * SD is the abbreviation for Standard Definition.
- Select “SD” when viewing works broadcasted in the SD image quality.

3 Press the [MENU] button to exit

Fine-tuning

After selecting a content type, adjust “Enhance”, “Dynamic Contrast”, and “Smoothing” according to your preference.

Item	Setting Range	Description
Enhance	0 to 100	Enhances the sharpness of the image.
Dynamic Contrast	0 to 100	Enhances the contrast of the image.
Smoothing	0 to 100	Enhances the blurriness of the image for a softer effect.

- By increasing the setting range, you can expect enhanced effects.
- Images are displayed in the original resolution (2K) when “4K Profile” is set to “Off”.
- “Enhance”, “Dynamic Contrast”, and “Smoothing” can be adjusted even when “4K Profile” is set to “Off”.
- * MPC is the abbreviation for Multiple Pixel Control.

About the analysis screen

By press the [MPC] button while the adjustment menu in the step 1 is on screen, the analysis screen is displayed. In the analysis screen, parts where the effect appear are highlighted in colors when “Enhance”, “Dynamic Contrast”, and “Smoothing” are adjusted.

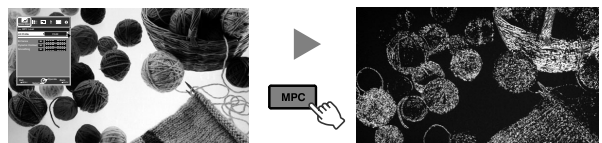

Adjustment menu display

Analysis screen

Highlighted color	Adjustment resulting in effects
Blue, green	Enhance
Red, yellow	Dynamic Contrast
Black	Smoothing

- To display the adjustment menu, operate any of the keys while the analysis screen is displayed.
- No adjustment can be made while the analysis screen is displayed. Make adjustments after returning to the adjustment screen.

Fine-tuning the Image Quality

Adjusting the Output Value of the Projected Image (Gamma)

You can adjust the output value of the projected image with respect to the video signal input.

Example of gamma adjustment

The overall image appear brighter with respect to the original image, making the dark areas more visible.

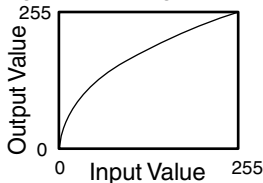

The photos are for illustrative purposes only.

Increases the contrast with respect to the original image, creating a greater sense of depth.

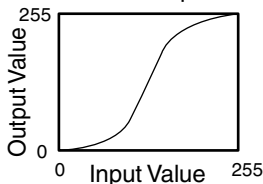

The photos are for illustrative purposes only.

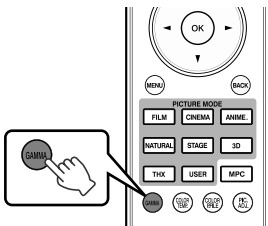

1 Press the [GAMMA] button

- Pressing the [GAMMA] button each time switches the setting in sequence.
- * The setting value varies with the model in use, as well as the input signal and Picture mode.

Gamma adjustment settings RS46

Setting	Input Signal	Description
A (3D)	3D	Recommended setting when viewing 3D movies.
B (3D)		The overall image appears brighter than that in "A (3D)".
C (3D)		The overall image appears to have a greater sense of depth than that in "A (3D)".
Normal	2D	Recommended setting for normal viewing.
A		Places more emphasis on the gradation compared to the "Normal" setting.
B		Image with a sense of depth that is characteristic of films.
C		Image contrast is enhanced compared to the "B" setting.
D		Image with brighter midtones compared to the "Normal" setting.
Custom 1 to Custom 3		Adjustable to a preferred gamma setting. (p. 43)

- During 3D signal input and when "Picture Mode" is set to "3D", Custom 1 to Custom 3 cannot be selected.
- During 3D signal input, the gamma setting is fixed at "Normal" if "Picture Mode" is set to a value other than "3D".
- During 2D signal input, the same gamma setting as 3D signal input is applied if "Picture Mode" is set to "3D".

Gamma adjustment settings **RS48**

Setting	Input Signal	Description
Normal	2D, 3D	Recommended setting for normal viewing.
A		Places more emphasis on the gradation compared to the “Normal” setting.
B		Image with a sense of depth that is characteristic of films.
C		Image contrast is enhanced compared to the “B” setting.
D		Image with brighter midtones compared to the “Normal” setting.
E		Recommended setting when viewing 3D movies.
F		The overall image is brighter than that in the “E” setting.
G		Recommended setting when viewing 3D TV, drama, and sports.
H		The overall image is brighter than that in the “G” setting.
Custom 1 to Custom 3	2D	Adjustable to a preferred gamma setting. (p. 43)

- During 3D signal input and when “Picture Mode” is set to “3D”, Custom 1 to Custom 3 cannot be selected.

Gamma adjustment settings **RS66 RS56**

Setting	Input Signal	Picture Mode	Description
Film 1	2D, 3D	Film	Image is close to the characteristics of Eastman Kodak Company movie films.
Film 2			Image is close to the characteristics of FUJIFILM Corporation movie films.
Film 3			Places more emphasis on the gradation compared to the “Film 1” setting.
Film 4			Image contrast is enhanced compared to the “Film 2” setting.
Normal		Modes other than Film	Recommended setting for normal viewing.
A			Places more emphasis on the gradation compared to the “Normal” setting.
B			Image with a sense of depth that is characteristic of films.
C			Image contrast is enhanced compared to the “B” setting.
D			Image with brighter midtones compared to the “Normal” setting.
E			Recommended setting when viewing 3D movies.
F			The overall image is brighter than that in the “E” setting.
G			Recommended setting when viewing 3D TV, drama, and sports.
H			The overall image is brighter than that in the “G” setting.
Custom 1 to Custom 3	2D	Modes other than 3D	Adjustable to a preferred gamma setting. (p. 43)

- During 3D signal input and when “Picture Mode” is set to “3D”, Custom 1 to Custom 3 cannot be selected.
- When “Picture Mode” is set to “THX”, the setting is fixed at THX.

Adjusting to the Preferred Gamma Setting (Custom Gamma)

Gamma setting can be adjusted according to your preferred video quality.

* During 3D signal input and when "Picture Mode" is set to "3D", gamma setting cannot be adjusted.

1 Press the [MENU] button to display the menu

2 Select "Picture Adjust" → "Advanced" → "Custom Gamma" from the menu

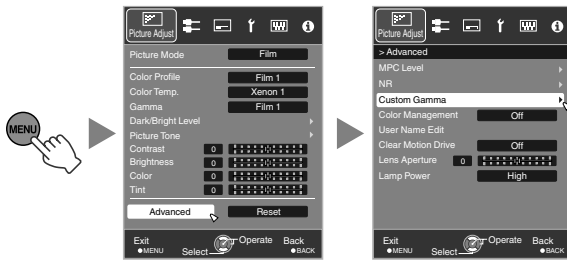

3 Select the item to set (Custom 1 to Custom 3), and press the [OK] button.

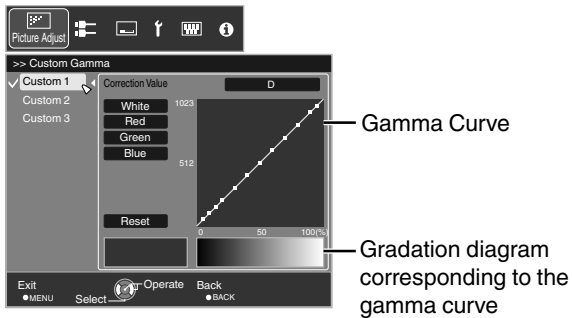

4 Select "Correction Value", and press the ◀▶ keys to select a value for correction to be based on (initial value)

- For details on the correction value, please refer to p. 41.

RS46

Normal, A, B, C, D, 1.8, 1.9, 2.0, 2.1, 2.2, 2.3, 2.4, 2.5, 2.6

RS48

Normal, A, B, C, D, E, F, G, H, 1.8, 1.9, 2.0, 2.1, 2.2, 2.3, 2.4, 2.5, 2.6

RS66 RS56

When "Picture Mode" is set to "Film": "Film 1", "Film 2", "Film 3", Film 4

When "Picture Mode" is set to a value other than "Film": Normal, A, B, C, D, E, F, G, H, 1.8, 1.9, 2.0, 2.1, 2.2, 2.3, 2.4, 2.5, 2.6

- The smaller the value, the brighter the dark areas of the image will become. At the same time, the bright areas will appear blown out.
- The factory settings for Custom 1 to Custom 3 are the same as that for the "Normal" setting.

5 Select the color to adjust, and press the [OK] button

6 Press the ◀▶ keys to select the area to adjust (from the 12 points on the gamma curve), followed by using the ▲▼ keys to adjust the brightness

- After adjustment is complete, press the [OK] button to confirm the setting.
- Selecting "Reset" restores the setting to the initial value (Normal).

7 Press the [MENU] button to exit

About gamma adjustment

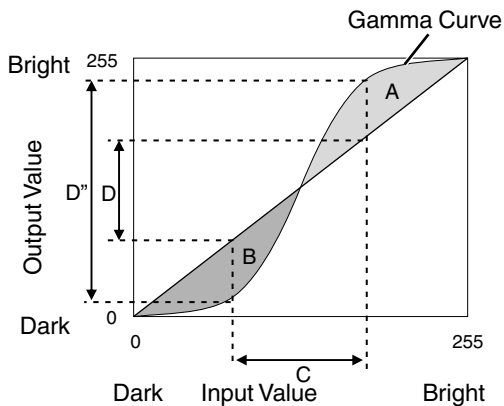

- When the gamma curve is a straight line:
The brightness and contrast of the video input will be the same as that of the video output.
- Area for which the gamma curve is above the straight line (A):
Video output appears brighter than the input.
- Area for which the gamma curve is below the straight line (B):
Video output appears darker than the input.
- Area for which the slope of the gamma curve is steep (midtone) (C):
The grayscale range of the video output becomes wider, and the contrast increases ($D \rightarrow D'$).

Compensating Highlights and Shadows (Dark/Bright Level)

You can adjust the image quality to produce a sharp contrast in the brightness.

- 1 Press the [MENU] button to display the menu
- 2 Select "Picture Adjust" → "Dark/Bright Level" from the menu

Shadow correction

Adjusts the shadows of the video input (the white, red, green, and blue tones can be adjusted separately).

- To do so, use the ◀▶ keys to move the cursor.
- Setting range: -7 (darkens the shadows) to +7 (brightens the shadows)

Highlight correction

Adjusts the highlights of the video input (the white, red, green, and blue tones can be adjusted separately).

- To do so, use the ◀▶ keys to move the cursor.
- Setting range: -7 (darkens the highlights) to +7 (brightens the highlights)

- 3 Press the [MENU] button to exit

Adjusting to the Preferred Color (Color Management)

You can adjust each of the following colors according to your preference: Red, Orange, Yellow, Green, Cyan, Blue, and Magenta.

1 Press the [MENU] button to display the menu

2 Select “Picture Adjust”→“Advanced”→“Color Management” from the menu

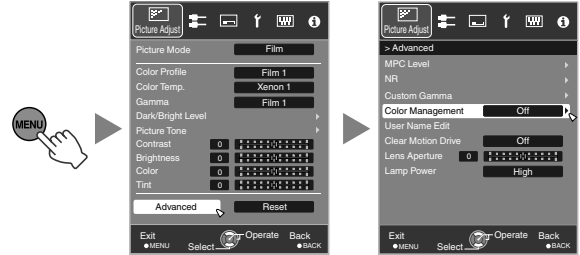

3 Adjust to the preferred color.

- ① Select the item to set (Custom 1 to Custom 3), and press the [OK] button.
- ② Select “Pause” and press the [OK] button to set the background for the current adjustment
 - While adjustment is in progress, the input image is displayed as the background.
 - “On”: pauses when inputting the video images.
 - “Off”: does not pause when inputting the video images.
- ③ Select “Color Selection”, and press the ◀▶ keys to select the color to adjust
 - For color adjustment, select the color from the following: “Red”, “Orange”, “Yellow”, “Green”, “Cyan”, “Blue”, “Magenta”.
 - Pressing the [HIDE] button enables you to check the image before adjustment.

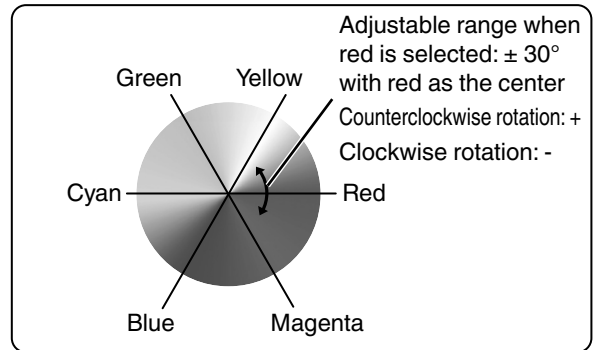

④ Adjust the selected color

Item	Setting Range	Description
Axis Position	-30 to 30	Fine-tune the position of the central axis of the selected color.
Hue	-30 to 30	Adjusts the hue (color tone).
Saturation	-30 to 30	Adjusts the color saturation (vividness). -30 (dull) to +30 (vivid)
Brightness	-30 to 30	Adjusts the brightness. -30 (dark) to +30 (bright)

- Selecting “Reset” resets all the adjustment data.

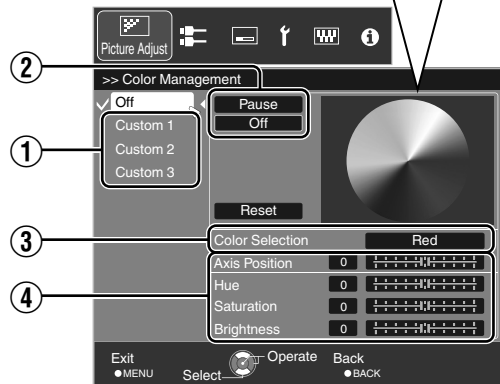

4 Press the [MENU] button to exit

Reducing the After-image of Fast-moving Images (Clear Motion Drive (C.M.D.))

By using the high-definition image interpolation technology developed by JVC, after-images that appear in fast-moving scenes can be reduced.

- This option is disabled during PC signal input, 3D signal input, and when “2D to 3D conversion” is set to “On”.
- For some scenes, interpolation may cause distortion in the image. In this case, set to “Off”.

■ Original Image



■ Interpolation Enabled

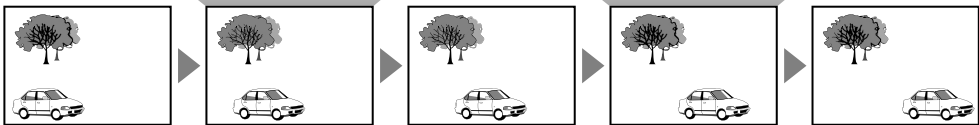

Intermediate Frame Generation

Intermediate Frame Generation

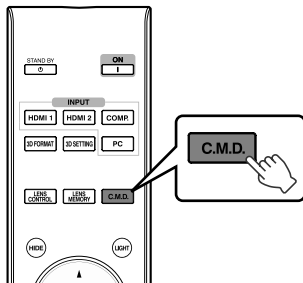

1 Press the [C.M.D.] button

- Pressing the [C.M.D.] button each time switches the mode in the following sequence: “Off”→“Low”→“High”→“Inverse Telecine”→“Off”...

Setting	Description
Off	Interpolation is not performed.
Low	Softens the image quality.
High	Image quality becomes softer than that of the “Low” setting.
Inverse Telecine	60i/60p video images such as those of TVs and DVDs. Suitable for original images that are 24-frame film sources. <ul style="list-style-type: none"> • Does not function for 24p video images.

* C.M.D. is the abbreviation for Clear Motion Drive.

* The [C.M.D.] button is positioned differently on the remote control depending on the model in use. (p. 17)

Adjustments and Settings in the Menu

Pressing the [MENU] button displays the menu.

Press the [▲▼◀▶] keys to select an item, followed by pressing the [OK] button to confirm the selection.

List of Menu Items

Picture Adjust

▶ Picture Mode	p. 37
▶ Color Profile RS66 RS56 RS48	p. 38
▶ Color Temp.	p. 49
▶ Gamma	p. 41
▶ Dark/Bright Level RS66 RS56 RS48	p. 50
▶ Picture Tone RS66 RS56 RS48	p. 50
▶ Contrast	p. 50
▶ Brightness	p. 50
▶ Color	p. 50
▶ Tint	p. 50
▶ Advanced	p. 51
↳ Sharpness RS46	p. 51
↳ MPC Level RS66 RS56 RS48	p. 40
↳ NR	p. 51
↳ Color Space RS46	p. 51
↳ Custom Gamma	p. 43
↳ Color Management RS66 RS56 RS48	p. 45
↳ User Name Edit	p. 52
↳ Clear Motion Drive	p. 46
↳ Lens Aperture	p. 52
↳ Lamp Power	p. 52
↳ Reset	p. 52

Input Signal

▶ HDMI	p. 53
▶ COMP.	p. 53
▶ PC RS66 RS56	p. 54
▶ Picture Position	p. 54
▶ Aspect (Video)	p. 33
▶ Aspect (PC)	p. 33
▶ Mask	p. 54
▶ Progressive	p. 54
▶ 3D Setting	p. 34

Installation

▶ Lens Control	p. 28
↳ Focus	p. 28
↳ Zoom	p. 28
↳ Shift	p. 28
↳ Image Pattern	p. 55
↳ Lock	p. 55
↳ Lens Memory Select	p. 29
↳ Lens Memory Save	p. 29
↳ Lens Memory Name Edit	p. 29
↳ Lens Center	p. 55
↳ Lens Cover RS66 RS56	p. 55
▶ Pixel Adjust RS46	p. 55
▶ Pixel Adjust RS66 RS56 RS48	p. 56
▶ Installation Style	p. 57
▶ Keystone	p. 57
▶ Pincushion	p. 57
▶ Anamorphic	p. 57
▶ Screen Adjust	p. 32
▶ Environment Setting RS66 RS56 RS48	p. 31
▶ Black Level RS46	p. 57

Display Setup

▶ Back Color	p. 61
▶ Menu Position	p. 61
▶ Menu Display	p. 61
▶ Line Display	p. 61
▶ Source Display	p. 61
▶ Logo	p. 61
▶ Language	p. 61

Function

▶ Trigger	p. 62
▶ Off Timer	p. 62
▶ High Altitude Mode	p. 62
▶ ECO Mode	p. 62
▶ Communication Terminal	p. 62
▶ Network	p. 62
▶ Remote Code	p. 63
▶ Lamp Reset	p. 67

Information

▶ Information	p. 64
---------------------	-------

Picture Adjust

Picture Mode

You can adjust the image quality according to the type of video image you are viewing.

- ➔ “Setting the Picture Mode” (p. 37)

Color Profile RS66 RS56 RS48

By setting the “Color Profile” (color space information) according to the “Picture Mode”, you can fine-tune the image quality according to the movie you are viewing.

- ➔ “Setting the Color Profile RS66 RS56 RS48” (p. 38)

Color Temp.

For setting the color temperature of the video image.

- When “Picture Mode” is set to “THX”, the setting is fixed at 6500K.

Preset

Setting	Description
Xenon 1 to Xenon 3 RS66 RS56 *Selectable only when “Picture Mode” is set to “Film”.	Color temperature that reproduces the characteristics of a xenon lamp used in cinemas. <ul style="list-style-type: none">• Xenon 1: A light source color that is emitted by a film projector• Xenon 2: A light source color emitted by a projector used for digital cinema• Xenon 3: A light source color that looks cooler than that of “Xenon 2”
5500K to 9500K (9 levels in increments of 500K)	Increasing the value enhances the blue tone of the video image, while decreasing the value enhances the red tone.
High Bright *Selectable only when “Picture Mode” is set to “3D”.	Color temperature that gives priority to brightness.
Custom 1 to Custom 3	The color temperature of video images can be adjusted manually and saved as one of the three customized settings.

Custom

Setting	Description
Gain Red, Gain Green, Gain Blue *Adjustable only when Custom 1 to Custom 3 is selected.	Adjusts each color in the bright parts of the video image. <ul style="list-style-type: none">• Setting range: -255 (reduces the red/green/blue tone) to 0 (enhances the red/green/blue tone)
Offset Red, Offset Green, Offset Blue	Adjusts each color in the dark areas of the video image. <ul style="list-style-type: none">• Setting range: -50 (reduces the red/green/blue tone) to +50 (enhances the red/green/blue tone)

Gamma

You can adjust the output value of the projected image with respect to the video signal input.

- ➔ “Adjusting the Output Value of the Projected Image (Gamma)” (p. 41)

Dark/Bright Level RS66 RS56 RS48

You can adjust the image quality to produce a sharp contrast in the brightness.

- ➔ “Compensating Highlights and Shadows (Dark/Bright Level)” (p. 44)

Picture Tone RS66 RS56 RS48

For reproducing the intensity of the exposure.

Setting	Description
Tone White	<ul style="list-style-type: none">• Setting range: -16 (darkens image for an underexposed effect) to +16 (brightens image for an overexposed effect)
Tone Red, Tone Green, Tone Blue	<ul style="list-style-type: none">• Setting range: -16 (underexposes red/green/blue) to +16 (overexposes red/green/blue)

Contrast

For adjusting the difference in brightness to produce an image with contrast.

- Setting range: -50 (little difference in brightness) to +50 (large difference in brightness)

Brightness

For adjusting the brightness of the video image.

- Setting range: -50 (darker) to +50 (brighter)

Color

For adjusting the color density of the video image.

- Setting range: -50 (lighter) to +50 (deeper)

Tint

For adjusting the hue of the video image.

- Setting range: -50 (reddish) to +50 (greenish)

Advanced

For fine-tuning the image quality.

Sharpness **RS46**

Setting	Description
Sharpness	Emphasizes the outline of the video image. <ul style="list-style-type: none">Setting range: 0 (blurry) to +50 (sharp)
Detail Enhance	Brings out details in the image, such as the hair or pattern of the clothes. <ul style="list-style-type: none">Setting range: 0 (weak) to +50 (strong)

MPC Level **RS66** **RS56** **RS48**

You can enjoy natural, expressive 4K images with a stronger sense of depth.

- ➔ “Adjusting Movies for Increased Expressiveness (Multiple Pixel Control) **RS66** **RS56** **RS48**” (p. 40)

NR

For reducing the noise of the video image.

Setting	Description
RNR	Adjusts the intensity of random noise elimination from the image. <ul style="list-style-type: none">Setting range: 0 (weak) to +16 (strong)
MNR *Adjustment cannot be made when “Picture Mode” is set to “3D” or during HD signal input.	Adjusts the intensity of mosquito noise elimination from the image. <ul style="list-style-type: none">Setting range: 0 (weak) to +16 (strong)
BNR *Adjustment cannot be made when “Picture Mode” is set to “3D” or during HD signal input.	Setting to “On” reduces the block noise of the video image.

Color Space **RS46**

For switching the color space of the projected image.

Setting	Description
Standard	Color space that is close to that of HDTV images.
Wide	Color space that is close to that of the DCI standard.
Off	Natural color space with no adjustments made.

Custom Gamma

Gamma setting can be adjusted according to your preferred video quality.

- ➔ “Adjusting to the Preferred Gamma Setting (Custom Gamma)” (p. 43)

Color Management **RS66** **RS56** **RS48**

Each of the colors is adjustable according to the user’s preference.

- ➔ “Adjusting to the Preferred Color (Color Management)” (p. 45)

User Name Edit

You can edit the “User 1” to “User 5” names in the Picture mode.

- Characters that are usable include alphabets (upper or lower case), numeric characters, and symbols.
- Enter not more than 10 characters.

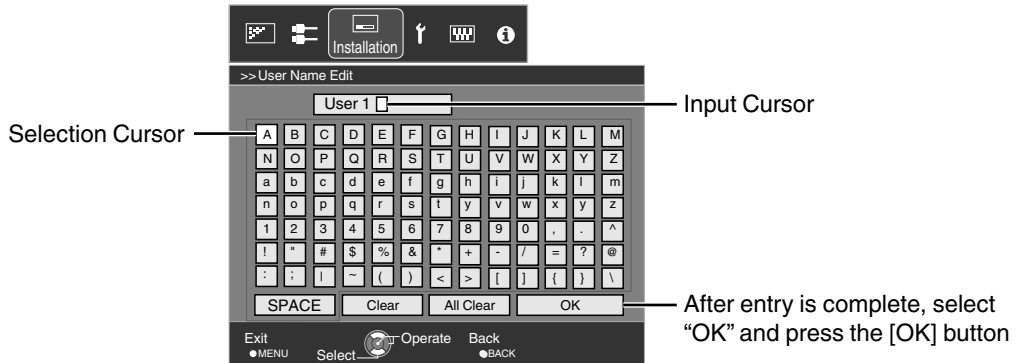

Clear Motion Drive

For reducing the after-image, which occurs in a fast-moving scene.

- “Reducing the After-image of Fast-moving Images (Clear Motion Drive (C.M.D.))” (p. 46)

Lens Aperture

For adjusting the amount of opening of the optical iris.

- Stopping down the iris reduces the brightness, while opening it up increases the contrast.
- Setting range: -15 (stops down) to 0 (opens up)

Lamp Power

The brightness of the lamp can be set to “Low” or “High”.

- The factory setting varies with the “Picture Mode”.
- Continuous use at the “High” setting may cause the lamp to darken faster.

Reset

For restoring the image quality adjustment settings to the factory default.

Input Signal

HDMI

Setting is enabled when the HDMI input terminal is selected.

Input

For setting the dynamic range (gradation) of the video input.

- If the dynamic range is not appropriate, the bright areas become overexposed, and the dark areas become underexposed.

Setting	Description
Standard	Select this setting if you are inputting video signals (dynamic range: 16 - 235).
Enhanced	Select this setting if you are inputting PC signals (dynamic range: 0 - 255).
Super White	Select this setting when inputting Super-white-compatible device signals (dynamic range: 16 - 255).

Level Check

For checking the dynamic range of the video input.

Color Space

For setting the color space of the input signal.

Setting	Description
Auto	Detects "YCbCr(4:4:4)", "YCbCr(4:2:2)", and "RGB" automatically.
YCbCr(4:4:4)	Select this setting when inputting YCbCr(4:4:4) video signals.
YCbCr(4:2:2)	Select this setting when inputting YCbCr(4:2:2) video signals.
RGB	Select this setting when inputting RGB video signals.

Control with HDMI (CEC)

For setting the HDMI link function.

- Setting to "On" enables this unit to be operated via operation on the connected device, such as power on/off and switching of input.

COMP. (Component Video)

Setting is enabled when the component video input terminal is selected.

Color Space

For setting the color space of the input signal.

Setting	Description
Y Pb/Cb Pr/Cr	Select this setting when inputting component video signals.
RGB	Select this setting when inputting RGB video signals.

Setting is enabled when the PC input terminal is selected.

Setting		Description
Auto Alignment		Adjusts "Tracking", "Phase", and "Picture Position" automatically.
Tracking		Adjusts the horizontal size and display position of the video image.
Phase		Adjusts flicker and blur in the video image.
Picture Position	Horizontal	Adjusts the horizontal position of the video image.
	Vertical	Adjusts the vertical position of the video image.

Picture Position (Horiz./Vert.)

Adjust the position if the edges of the image are partially missing due to the timing of horizontal and vertical synchronization signals.

* Adjustment cannot be made during 3D signal input.

Aspect (Video) / Aspect (PC)

The screen size of the projected image can be adjusted optimally according to the original screen size (aspect) that has been input.

➔ "Adjusting the Screen Size (Aspect)" (p. 33)

Mask

For hiding the peripheral area of the image with a mask (black strip).

■ Off



Setting	Description
Off	Not masked.
2.5%	Masks about 2.5% of the peripheral area of the image.
5%	Masks about 5.0% of the peripheral area of the image.
Custom	Masks about 0% to 5% of the four sides of the image.

■ On



Mask: black strip around the periphery

Progressive

For converting the interpolation setting of the interlaced signals.

Setting	Description
Auto	Performs interpolation by automatically detecting whether the interlaced signals are converted from 24p video images, such as those in film movies, or interlaced signals of video materials.
Off	Interpolates video images as interlaced signals of video materials, etc.

3D Setting

For setting 3D movies for viewing.

➔ "Viewing 3D Movies" (p. 34)

Installation

Lens Control

Focus / Zoom / Shift

For adjusting the lens according to the projection position

- ➔ “Adjusting the Lens According to the Projection Position” (p. 28)

Image Pattern

Setting	Description
On	Displays the lens adjustment pattern.
Off	Displays external signals, and does not display the lens adjustment pattern.

Lock

Setting	Description
On	Locks the lens to prevent any erroneous operation on the adjustments. <ul style="list-style-type: none">• Operation of the lens control feature is disabled when “On” is selected.
Off	Does not lock the lens.

Lens Memory Select / Lens Memory Save / Lens Memory Name Edit

The focus, zoom, and shift settings can be saved or retrieved, so you can switch easily to a different aspect ratio (screen size) according to the image.

- ➔ “Saving and Retrieving Adjustment Settings” (p. 29)

Lens Center

Returns the lens position to the center.

Lens Cover **RS66** **RS56**

Setting	Description
Auto	Opens/closes the lens cover according to the power on/off operation.
Open	Leaves the lens cover open regardless of the power on/off mode.

Pixel Adjust **RS46**

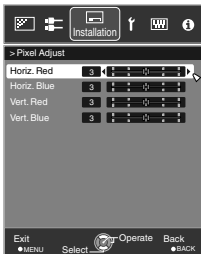

For adjusting color fringing of the video image in the horizontal and vertical directions.

Setting	Description
Horiz. Red / Horiz. Blue	Setting range: 1 (moves red/blue to the left) to 5 (moves red/blue to the right)
Vert. Red / Vert. Blue	Setting range: 1 (moves red/blue downward) to 5 (moves red/blue upward)

- It is not possible to maintain the consistency of all pixels on the screen. Due to the equipment, there will always be some differences. Color fringing also varies depending on the screen position.
- The horizontal and vertical directions are reversed when the image is flipped laterally or vertically.
- To adjust, use still images with distinct outlines.

Adjust

For setting the adjustment feature to “On” or “Off”.

Adjust Area

Setting	Description
Whole	Adjusts the entire image.
Zone	Enables fine adjustment of each zone by dividing the screen into 11 vertical x 11 horizontal zones.

Adjust Color

For selecting the color to adjust (“Red” or “Blue”).

Adjust Pattern Color

For setting the adjustment pattern color to “White” or “Yellow / Cyan”.

Adjust(Pixel)

When “Adjust Area” is set to “Whole”, adjustment can be made by moving in units of one pixel on the screen of the color selected in “Adjust Color”.

➔ “Whole Adjust (Pixel) Operation Procedure **RS66 RS56 RS48**” (p. 58)

* Adjustment cannot be made when “Adjust Area” is set to “Zone”.

Setting	Description
H (Horizontal)	Setting range: -2 (moves red/blue to the left) to +2 (moves red/blue to the right)
V (Vertical)	Setting range: -2 (moves red/blue downward) to +2 (moves red/blue upward)

Adjust(Fine)

When “Adjust Area” is set to “Whole”, adjustment can be made by moving in units of 1/16 pixel on the screen of the color selected in “Adjust Color”.

➔ “Whole Adjust (Fine) Operation Procedure **RS66 RS56 RS48**” (p. 59)

When “Adjust Area” is set to “Zone”, the screen is divided into 11 vertical x 11 horizontal zones, and fine adjustment of each zone is possible.

➔ “Zone Adjust Operation Procedure **RS66 RS56 RS48**” (p. 60)

Setting	Description
H (Horizontal)	Setting range: -31 (moves red/blue to the left) to +31 (moves red/blue to the right)
V (Vertical)	Setting range: -31 (moves red/blue downward) to +31 (moves red/blue upward)

Reset

Restores all pixel adjustment data to the factory default.

Installation Style

For setting to “Front”, “Ceiling Mount (F)”, “Rear”, or “Ceiling Mount (R)” according to the installation status of the projector.

- “Front” or “Ceiling Mount (F)” is set when projector is installed in the front with respect to the screen.
- “Rear” or “Ceiling Mount (R)” is set when projector is installed in the rear with respect to the screen.

Keystone

For correcting any keystone distortion that occurs when the projector is installed at an angle with respect to the screen.

- Horizontal setting range: -40 to +40
- Vertical setting range: -30 to +30

* Correction cannot be performed during 3D signal input.

Pincushion

For correcting distortion of the projection screen.

- Setting range: -20 (pin-cushion) to +20 (barrel)

* Correction cannot be performed during 3D signal input.

Anamorphic

Configure this setting when an anamorphic lens is used.

Setting	Description
A	Projects the 2.35:1 image with it stretched in the vertical direction only.
B	Projects the 16:9 image with it compressed in the horizontal direction only.
Off	Projects the 2.35:1 image without any changes.

Screen Adjust

By selecting the optimal correction mode according to the characteristics of the screen in use, corrections can be performed to reproduce natural images with balanced colors.

- ➔ “Setting Screen Correction” (p. 32)

Environment Setting RS66 RS56 RS48

By configuring “Environment Setting” according to the viewing environment, image quality adjustment and correction according to environmental differences are performed automatically to minimize any influence on the image quality.

- ➔ “Adjusting Image Quality Automatically According to the Viewing Environment RS66 RS56 RS48” (p. 31)

Black Level RS46

For setting the black level in the environment of use.

- Setting range: 0 to 10

A frame as shown on the right appears at the center (gradation is accentuated in the illustration, but not in the actual image).

The current black tone is displayed on the right side. Adjust accordingly until the boundary line with the left frame is no longer noticeable.

- This adjustment reduces the black side, and has a subtle influence from the black (dark) side to the white (bright) side. Adjust according to your preference.



Whole Adjust (Pixel) Operation Procedure **RS66 RS56 RS48**

For making general adjustments to slight color fringing in the horizontal/vertical directions of the video image.

- ① Set “Adjust Area” to “Whole”
- ② Select “Adjust Color” and “Adjust Pattern Color”
- ③ Select “Adjust(Pixel)”, and press the [OK] button
 - The selected adjustment pattern and Adjustment (Pixel) window are displayed.

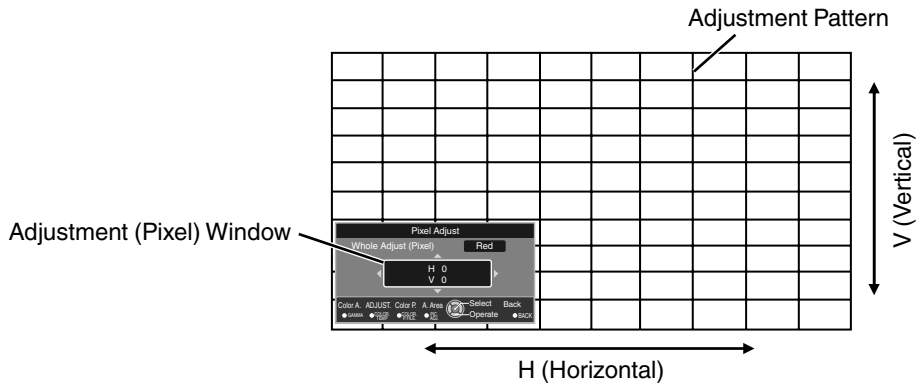

- ④ Press the [OK] button to enter the Adjustment mode
- ⑤ Use the [▲▼◀▶] keys to move and adjust the pixels in the vertical and horizontal directions across the entire screen.
 - The adjustment setting appears at the center of the Adjustment (Pixel) window.

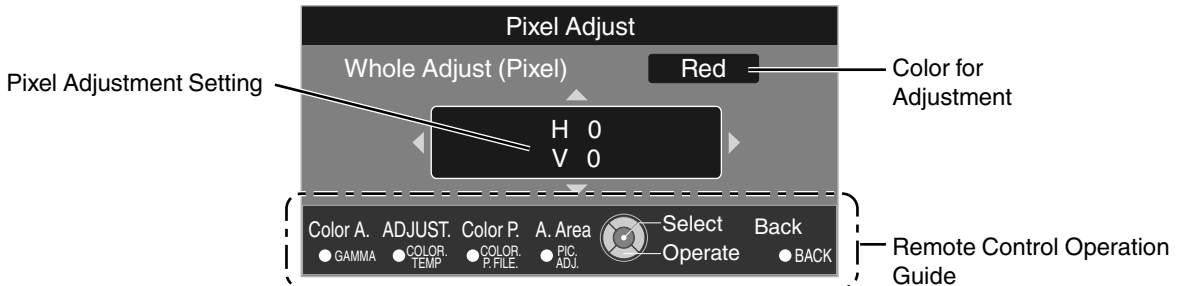

- ⑥ After adjustment is complete, press the [BACK] button to exit the Adjustment mode

Remote Control Operation Guide

Button Name	Description of Operation
[GAMMA]	Changes “Adjust Color”.
[COLOR TEMP.]	Switches between “Adjust(Pixel)” and “Adjust(Fine)”. <ul style="list-style-type: none"> • Switches to “Adjust(Pixel)” when “Adjust Area” is set to “Zone”.
[COLOR P.FILE]	Changes “Adjust Pattern Color”.
[PIC ADJ.]	Switches “Adjust Area”. <ul style="list-style-type: none"> • A zone cursor appears on the adjustment pattern when the “Zone” setting is selected.

Whole Adjust (Fine) Operation Procedure RS66 RS56 RS48

For making general adjustments on the misalignment of the entire screen using “Adjust(Pixel)”, followed by making fine adjustments.

- ① Set “Adjust Area” to “Whole”
- ② Select “Adjust Color” and “Adjust Pattern Color”
- ③ Select Adjust(Fine), and press the [OK] button
 - The selected adjustment pattern and Fine window are displayed.
 - The adjustable range may be smaller depending on the pixels being adjusted on the entire screen.

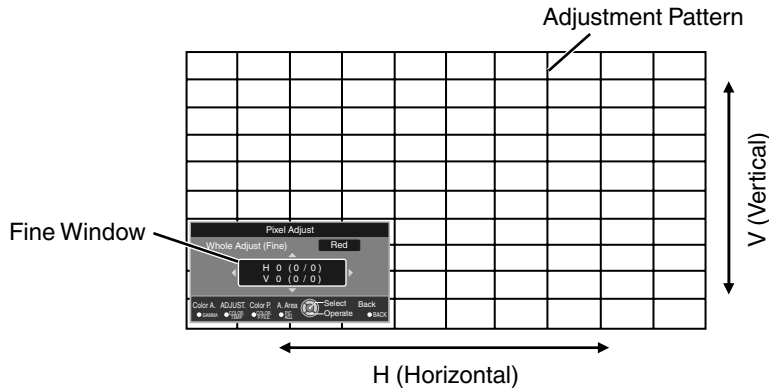

- ④ Press the [OK] button to enter the Adjustment mode
- ⑤ Use the [▲▼◀▶] keys to move and adjust the pixels in the vertical and horizontal directions across the entire screen.
 - The adjustment setting appears at the center of the Fine window.

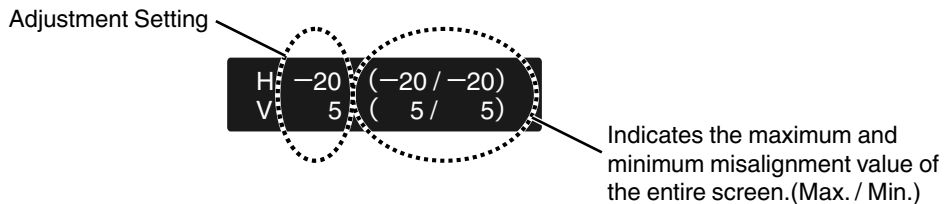
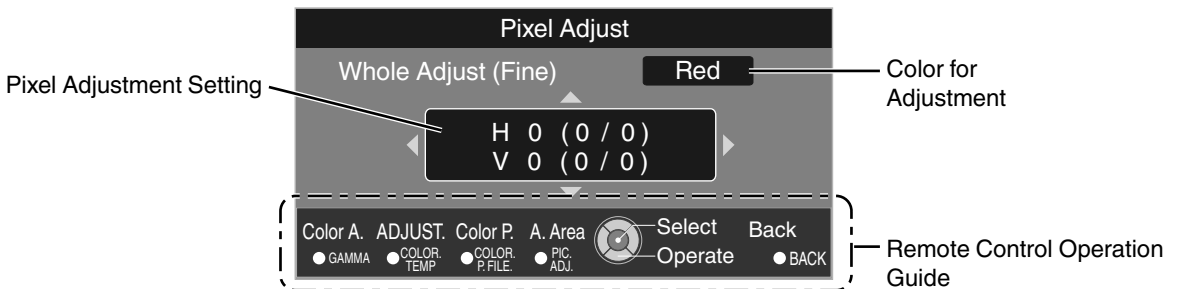

- ⑥ After adjustment is complete, press the [BACK] button to exit the Adjustment mode

MEMO

- If both the maximum overall screen misalignment of H (horizontal direction) and V (vertical direction) are “31”, you cannot select a value that is larger than the displayed setting even when the adjustment setting is lower than the maximum value.
- If the minimum overall screen misalignment is “-31”, you cannot select a value that is smaller than the displayed setting even when the adjustment setting is higher than the minimum value.

Zone Adjust Operation Procedure RS66 RS56 RS48

For fine-tuning misalignments on a part of the screen after adjusting the overall screen misalignment using “Adjust(Pixel)” and “Adjust(Fine)”.

- The screen can be divided vertically and horizontally into 10 sections for partial adjustments to be made.

- ① Set “Adjust Area” to “Zone”
- ② Select “Adjust Color” and “Adjust Pattern Color”
- ③ Select Adjust(Fine), and press the [OK] button

- The selected adjustment pattern and Zone Adjustment window are displayed.
- The adjustable range may be smaller depending on the pixels being adjusted on the entire screen.

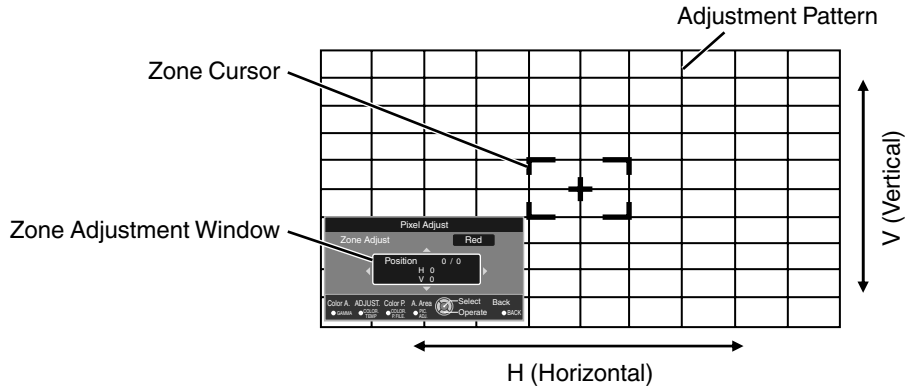

- ④ Press the [▲▼◀▶] keys to move the cursor to the point to be adjusted
 - ⑤ Press the [OK] button to enter the Adjustment mode
 - ⑥ Use the [▲▼◀▶] keys to move and adjust the pixels in the vertical and horizontal directions across the entire screen.
- The adjustment setting appears at the center of the Zone Adjustment window.

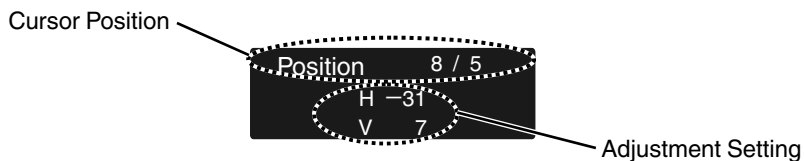
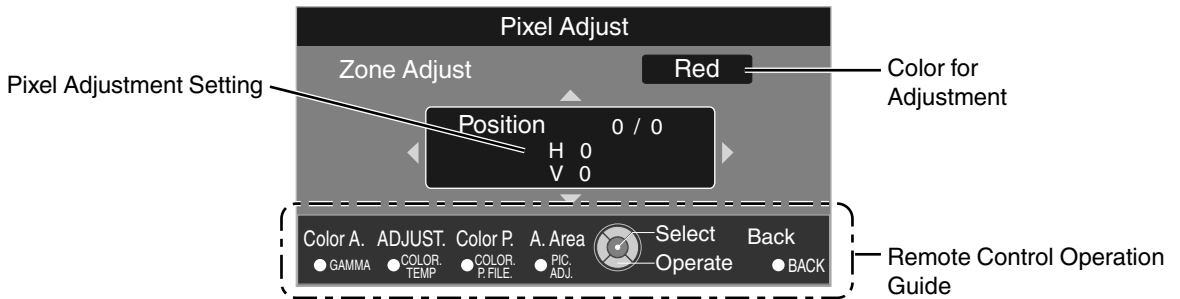

- ⑦ After adjustment is complete, press the [BACK] button to exit the Adjustment mode

Display Setup

Back Color

For setting the color of the background to “Blue” or “Black” when there is no input signal.

Menu Position

For setting the display position of the menu.

Menu Display

Setting	Description
15sec	The menu display disappears if it is not operated for 15 seconds.
On	Displays the menu at all times.

Line Display

Setting	Description
5sec	Shows the input terminal for 5 seconds when input is switched.
Off	Not displayed.

Source Display

Setting	Description
On	Displays the signal when input is switched.
Off	Not displayed.

Logo

Setting	Description
On	Displays the “D-ILA” logo for 5 seconds during startup.
Off	Not displayed.

Language

For setting the display language to “日本語”, “English”, “Deutsch”, “Español”, “Italiano”, “Français”, “Português”, “Nederlands”, “Svenska”, “Norsk”, “Русский”, “中文”, or “繁體中文”.

Function

Trigger

For configuring 12 V output to an external screen equipped with a trigger function.

Setting	Description
Off	No output.
On (Power)	Outputs control signals (12 V) from the trigger terminal when the power is turned on. <ul style="list-style-type: none">• After the power is turned off, output stops when the unit shifts to the Standby mode after cooling is complete.• You can also output signals in the Standby mode by pressing the [OK] button.
On (Anamo)	Outputs control signals when the “Anamorphic” setting is switched from “Off” to “A” or “B”.

Off Timer

For setting the timing to power off the unit automatically (“1 Hour”, “2 Hours”, “3 Hours”, or “4 Hours”) when it is not operated for a period of time.

High Altitude Mode

Set to “On” when using the projector at a location of low atmospheric pressure (higher than 900 m above sea level).

ECO Mode

Setting	Description
On	Minimizes power consumption in the Standby mode. <ul style="list-style-type: none">• If there is no signal transmission or operation for 30 minutes while an image is projected, the power is turned off automatically.
Off	Set to “Off” if RS-232C / LAN communication is performed or the HDMI link function is used in the Standby mode.

Communication Terminal

For setting the external control terminal to be used to “RS-232C” or “LAN”.

Network

Setting	Description	
DHCP Client	On	Obtains the IP address automatically from the DHCP server inside the connected network.
	Off	For configuring the network settings manually.
IP Address	For configuring the IP address.	
Subnet Mask	For configuring the subnet mask.	
Default Gateway	For configuring the default gateway.	
MAC Address	Displays the MAC address of the unit.	
Set	Applies the network settings.	

Remote Code

For changing the remote control code.

- You need to configure the remote control according to the settings of this unit.
On the remote control unit, press the [MENU] and [BACK] buttons at the same time for three seconds or longer to switch the code.
 - The backlight of the remote control blinks 3 times: change the remote control code to “A”
 - The backlight of the remote control blinks 2 times: change the remote control code to “B”

Setting	Description
A	Change the remote control code from “B” to “A”.
B	Change the remote control code from “A” to “B”.

Lamp Reset

For resetting the lamp time to “0”.

- ➔ “Resetting the Lamp Time” (p. 67)

Glossary of Network Terminology

DHCP	: Abbreviation for Dynamic Host Configuration Protocol. This is a protocol for the network to assign an IP address automatically to the connected device.
IP Address	: Numeric characters for identifying the device that is connected to the network.
Subnet Mask	: Numeric characters that define the bit count used for the network address that is a segment of the IP address.
Default Gateway	: Server for communicating beyond the network that is divided by the subnet mask.
MAC Address	: Abbreviation for Media Access Control address. This is a number that is unique to each network adapter. Each of the network adapters is assigned with a unique MAC address.

Information

During video signal input

Setting	Description
Input	Displays video input terminal.
Source	Displays the input source.
Deep Color	Displays the color bit depth of the input video signal. <ul style="list-style-type: none">• Not displayed when YCbCr(4:2:2) is input.• Displayed when Deep Color information is received from the source device.
Lamp Time	Displays the lamp time.
Soft Ver.	Displays the firmware version.

During PC signal input

Setting	Description
Input	Displays video input terminal.
Resolution	Displays the image resolution.
H Frequency	Displays the horizontal frequency.
V Frequency	Displays the vertical frequency.
Deep Color	Displays the color bit depth of the input video signal. <ul style="list-style-type: none">• Not displayed when YCbCr(4:2:2) is input.• Displayed when Deep Color information is received from the source device.
Lamp Time	Displays the lamp time.
Soft Ver.	Displays the firmware version.

Replacing the Lamp

The lamp is a consumable item. If the image appears dark or the lamp goes out, replace the lamp unit.

- When the lamp replacement time approaches, the user is notified with a message displayed on the screen and by the indicator. (p. 81)

Lamp Replacement Procedure

CAUTION

- Do not insert your hands into the opening of the lamp. This could cause significant deterioration in the performance of the equipment, or lead to injury and electric shock.
- Do not replace the lamp immediately after the unit has been used. Allow a cooling period of at least one hour before replacement. The temperature of the lamp is still high, and may cause burn injuries.
- Do not subject the lamp unit to shock. Doing so may cause lamp blowout.
- Do not use a flammable air duster to clean the internal parts of the unit. Doing so may cause fire.
- Use only genuine replacement parts for the lamp unit. Also, never attempt to reuse an old lamp unit. This may cause the unit to malfunction.
- Do not touch the surface of a new lamp. Doing so may shorten the lamp life and cause lamp blowout.
- When replacing the lamp, be careful not to injure yourself as the lamp may be broken.
- When replacing the lamp of a projector suspended from the ceiling, work at height is required. This is a dangerous operation. Please consult our service center.

1 Pull out the power plug from the power outlet

2 Remove the lamp cover

- Remove the screws with a ⊕ screwdriver.

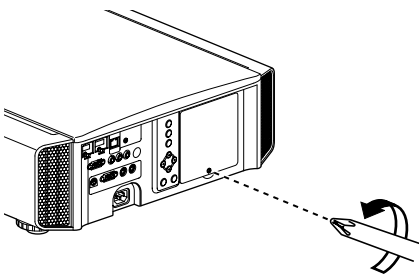

3 Loosen the screws of the lamp unit

- Loosen the screws with a ⊕ screwdriver.

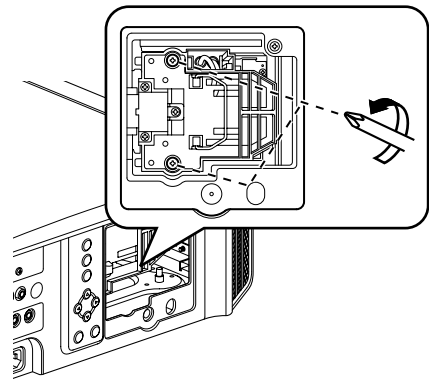

4 Pull out the lamp unit

- Grasp the handle and pull out the lamp unit.

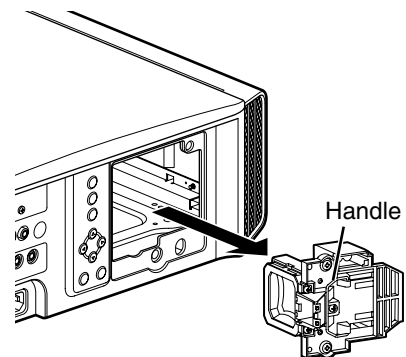

5 Install the new lamp unit

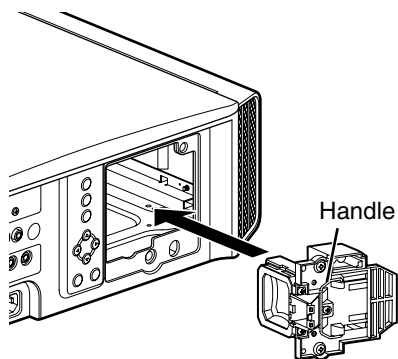

6 Tighten the screws of the new lamp unit

- Tighten the screws with a ⊕ screwdriver.

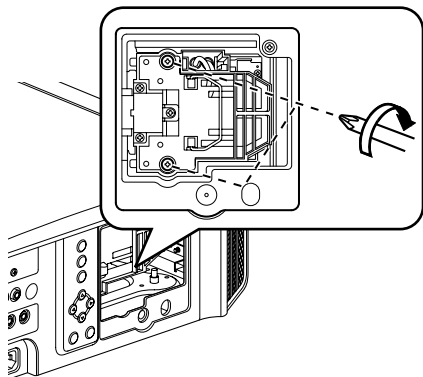

7 Attach the lamp cover

- Insert the two tabs at the top and bottom of the lamp cover into the unit.
- Tighten the screws with a ⊕ screwdriver.

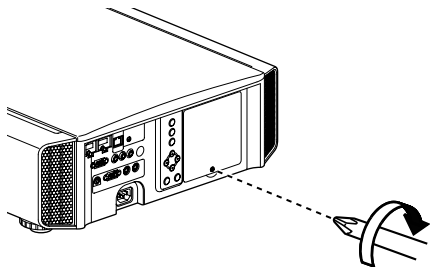

MEMO

Usable lamp life

- When the lamp is used with “Lamp Power” set to “Low”, the lamp life on this unit is approximately 4000 hours. This is the average usable time and not a guaranteed value.
- The lamp life may not reach 4000 hours depending on the operating conditions.
- When the lamp has reached the end of its usable life, deterioration progresses rapidly.
- When the video image appears dark, when the color tone looks unnatural, or when the image flickers, replace the lamp unit with a new one promptly.

Purchasing a lamp unit

Please consult your authorized dealer or nearby service center.

- Lamp unit
Product no.: PK-L2312U

Lamps with a different product number or those for other projector models cannot be used.

Information about the lamp

An ultra-high pressure mercury lamp with a high internal pressure is used in the projector.

Due to the characteristics of this lamp, it may blow out with a loud noise or go out when it is subject to shock or after using for a prolonged period of time (the time before the lamp blows out or goes out varies considerably with each lamp as well as the operating conditions).

After replacing the lamp

- Do not place the removed lamp unit at a place that is within reach by children or anywhere near inflammable items.
- Dispose used lamp units in the same way as fluorescent lamps. Follow the regulations of your local community for disposal.

Resetting the Lamp Time

Resetting the lamp time from the menu screen

- 1 Press the [MENU] button to display the menu
- 2 Select "Function" → "Lamp Reset" from the menu

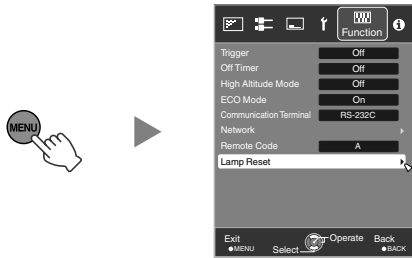

- 3 On the Reset Lamp Time? screen, select Yes and press the OK button
 - The lamp time is reset to zero.

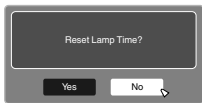

Resetting the lamp time using the remote control

- 1 Insert the power plug into the power outlet
- 2 Make sure that you operate the remote control in the Standby mode (the power plug is inserted into the outlet, but the power is not turned on)
 - Press in the order as shown.
 - Make sure that you press a button within two seconds after the last button is pressed. Press the last button for at least two seconds.

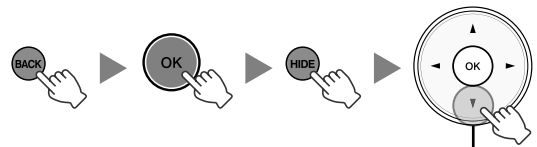

Press for 2 seconds or longer

- The "LAMP" indicator and "STANDBY/ON" indicator blink alternately for three seconds. After that, the unit switches to the Standby mode.

MEMO

- Reset the lamp time only when you have replaced the lamp.
If the lamp time is reset while a lamp is in use, you may lose track of the timing for replacing the lamp. Doing so may result in using the lamp beyond the estimated limit, thereby causing lamp blowout.

Maintaining the Cabinet and Remote Control

- Gently wipe off dirt on the cabinet with a soft cloth.
- If it is extremely dirty, wet a cloth in water, wring dry and use it to wipe off the dirt, followed by wiping again with a dry cloth.
- Pay attention to the following as the cabinet may deteriorate in condition or the paint may come off.
 - Do not wipe with thinner or benzine
 - Do not allow prolonged contact with rubber or plastic products
 - Do not spray volatile chemicals such as insecticide

Cleaning and Replacing the Filter

Clean the filter regularly. Otherwise, the air intake efficiency may deteriorate, and malfunction may occur.

CAUTION

- Make sure that you pull out the power plug from the outlet before cleaning or replacing the filter.
- Before turning this unit upside down and placing it on the floor or a table, make sure that you lay a soft rag in advance to prevent the projector from being scratched.

1 Remove the inner filter

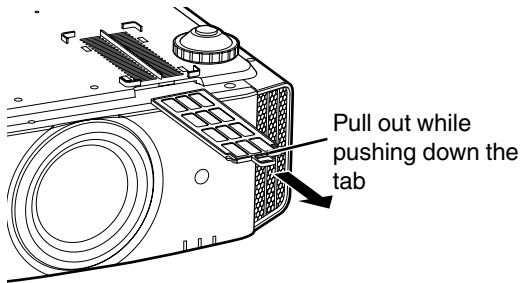

2 Clean the filter

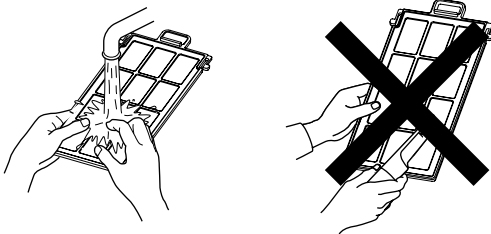

- Wash the filter with water and dry it in a shaded area.
- If the filter is extremely dirty, clean it with a neutral detergent. Put on rubber gloves when using a neutral detergent.
- After washing the filter with water, make sure that it is completely dry before reinstalling. Otherwise, electric shock or malfunction may occur.
- Do not clean the filter with a vacuum cleaner or air duster. The filter is soft and may be easily damaged.

3 Reinstall the inner filter

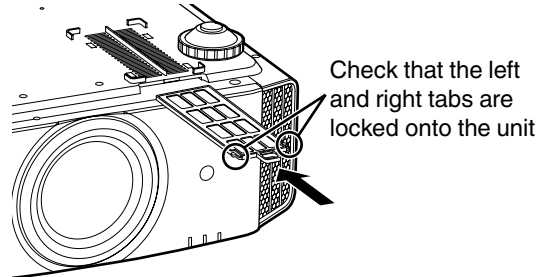

If the filter is damaged or too dirty to be cleaned

- Replace with a new filter. A dirty filter will dirty the internal parts of the unit and cause shadows to appear on the video image.
- To purchase a new filter or when there is dirt in the internal parts of the unit, consult your authorized dealer or nearby service center.
- Inner filter (exchangeable filter)
Product no.: PC010661199

Troubleshooting

Before sending the unit to your authorized dealer for repair, please check the following points.

The following symptoms are not malfunctions.

You do not need to worry about the following symptoms if there is no abnormality on the screen.

- A part of the top or front surface of the unit is hot.
- A creaking sound is heard from the unit
- An operating sound is heard from the inside of the unit.
- Color smear occurs on some screens

This unit is a digital device. This unit may become unable to operate normally due to external static or noise. Perform the following operations when such malfunctions occur.

- ① If the unit is in the Standby mode, pull out the power plug, followed by inserting it again
- ② Press the  [STANDBY/ON] button on the main unit to turn on the power again

When “High Altitude Mode” is set to “On”, and “Lamp Power” is set to “High” during 3D mode, the fan will make louder noise than usual since it is designed to run at high speed in 3D mode.

Power is not supplied

Check	Action	Refer to
Is the power cord disconnected?	Insert the power cord (plug) firmly.	p. 25
Is the lamp cover properly shut?	If the unit is in the Standby mode, remove the power plug and close the lamp cover properly. After that, insert the plug again.	p. 66
Is the lamp in the Cool-down mode?	After exiting the Cool-down mode, turn on the power again.	p. 27

The unit works when power is turned on, but stops abruptly after a few minutes

Check	Action	Refer to
Are the air inlets and exhaust vent blocked?	Leave proper clearance when installing the unit	p. 14, 15 p. 19
Is the filter dirty?	Clean the filter.	p. 68

Video image does not appear

Check	Action	Refer to
Is the correct external input selected?	Select the correct external input terminal.	p. 26
Is the power of the AV device turned on?	Turn on the power of the AV device and play the video.	p. 22
Is the AV device properly connected?	Connect the AV device properly.	p. 22
Are the correct signals being output from the AV device?	Set the AV device properly.	p. 22
Is the cable in use an HDMI-certified cable?	Use an HDMI-certified high-speed cable. Also, use as short a cable as possible.	p. 22
Is “Control with HDMI” set to “On”?	If the video image does not appear when “Control with HDMI” is set to “On”, change the setting to “Off” and power on this unit and the external device again.	p. 53
Is the video image temporarily hidden?	Press the [HIDE] button	p. 26

Remote control does not work

Check	Action	Refer to
Are the batteries correctly loaded?	Match the polarities (⊕ ⊖) correctly when loading the batteries.	p. 18
Are the batteries exhausted?	Replace with new batteries.	p. 18
Is there an obstructing object between the remote control and remote sensor?	Remove any obstructing object.	p. 18
Is the remote control held too far away from the unit?	Hold the remote control closer to the sensor during use.	p. 18
Are the IR (infrared) 3D GLASSES and 3D SYNCHRO EMITTER in use?	As there is a possibility of signal interference, when you are using the IR (infrared) 3D GLASSES together with the 3D SYNCHRO EMITTER, try adjusting the orientation of the 3D SYNCHRO EMITTER.	p. 34

Unable to view 3D images

Check	Action	Refer to
Is the power of the 3D GLASSES turned on?	If you are using the PK-AG2 or PK-AG33D GLASSES, turn on the power manually.	Check the instruction manual of the 3D GLASSES and 3D SYNCHRO EMITTER.
Are the 3D GLASSES charged?	Check the battery (charge) of the 3D GLASSES.	
Are the 3D GLASSES and 3D SYNCHRO EMITTER too far away from each other?	Position them at an appropriate distance.	
Is the correct 3D format selected?	If the format does not switch automatically, configure 3D Format in the setting menu.	p. 35

Color does not appear or looks unnatural

Check	Action	Refer to
Is the AV device properly connected?	Connect the AV device properly.	p. 22
Is the image correctly adjusted?	Adjust "Color" and "Tint" accordingly.	p. 50
Is the color space of the input signal correctly set?	Set "Color Space" properly.	p. 53

Video image is fuzzy

Check	Action	Refer to
Is the focus correctly adjusted?	Adjust the focus.	p. 28
Is the unit placed too near or too far away from the screen?	Set the unit at a correct distance from the screen.	p. 77

Video images are missing

Check	Action	Refer to
Has screen mask been configured?	Set "Mask" to "Off".	p. 54
Is the display position misaligned?	Alter the "Picture Position" value so that the entire image appears on the screen.	p. 54

Projected image is dark

Check	Action	Refer to
Is the lamp near exhaustion?	Check the lamp time in the “Information” menu. Prepare a new lamp unit or replace as soon as possible when the lamp is near exhaustion.	p. 64 p. 65
Is the image quality correctly adjusted?	Adjust “Picture Adjust” and “Lens Aperture” accordingly.	p. 37 p. 52

Power is cut off suddenly

Check	Action	Refer to
Has “Off Timer” been configured?	Set “Off Timer” to “Off”.	p. 62
Has “ECO Mode” been configured?	Set “ECO Mode” to “Off”.	p. 62

The lens cover does not close

Check	Action	Refer to
Is “Lens Cover” set to “Open”?	Set “Lens Cover” under “Lens Control” in the setting menu to “Auto”.	p. 55



The internal cooling fan emits a loud noise

Check	Action	Refer to
Is the exhaust vent blocked? Is the unit used near a heater or air-conditioner?	Check the condition of installation.	p. 19

There are small black or colored dots on the screen

The D-ILA device is manufactured using high-precision technologies, but there may be some (less than 0.01%) missing pixels or pixels that remain permanently lit. This is not a malfunction.

When the following messages appear...

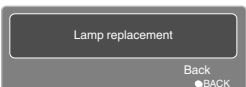
Message	Description	Action
	<ul style="list-style-type: none"> No device is connected to the input terminal The input terminal is connected but there is no signal 	Input the video signals.
	A video signal that cannot be used with this unit has been input (The names of input terminals such as “COMP.” will be displayed in yellow).	Input video signals that can be used.
	This message is displayed when the accumulated lamp time has exceeded 2900 hours. To clear the message, press the [BACK] button.	Get ready a new lamp unit and replace as soon as possible. Reset the lamp time after replacing the lamp. (p. 65, 67)

External Control

It is possible to control this unit by connecting it to a PC using an RS-232C cross cable (D-sub 9-pin). The projector can be controlled by connecting it to a PC through the computer network with a LAN cable for control commands to be sent to the projector.

- Please use it after you have gained proper understanding from professional books or consulting the system administrator.

RS-232C Specifications

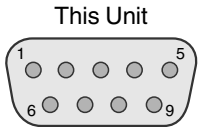

Pin No.	Signal	Function	Signal Direction
2	RxD	Receive data	PC → This unit
3	TxD	Transmission data	This unit → PC
5	GND	Signal ground	—
1, 4, 6 - 9	N/C	—	—

- PC refers to the controller, such as a personal computer.

Mode	Non-synchronous
Character length	8 bit
Parity	None
Start bit	1
Stop bit	1
Data rate	19200 bps
Data format	Binary

TCP/IP Connection

Before controlling via LAN, it is necessary to establish connection of the TCP layer by a “3-way handshake”, followed by sending out “PJREQ” and receiving “PJACK” within five seconds after the projector sends out “PJ_OK” for connection authentication.

If you are unable to complete sending within five seconds, or when “PJ_NG” or “PJNAK” is received, check the operating status of the projector, followed by performing the steps again starting from establishment of a TCP connection,

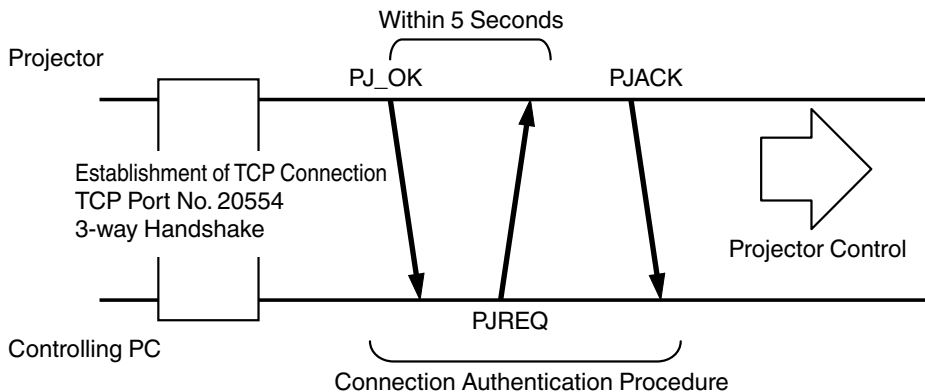

Command Format

The command between this unit and the computer consists of “Header”, “Unit ID”, “Command”, “Data” and “End”.

- Header (1 byte), Unit ID (2 bytes), Command (2 bytes), Data (n bytes), End (1 byte)

Header

This binary code indicates the start of communication.

Binary Code	Type	Description
21	Operating command	PC → This unit
3F	Reference command	PC → This unit
40	Response command	This unit → PC
06	ACK	This unit → PC (returns to PC after the command is accepted without error)

Unit ID

This is a code that specifies the unit. The binary code is fixed at “8901”.

Command and data

Operating command and data (binary code)

Command	Type	Description
0000	Connection check	Check whether communication is enabled between this unit and the PC during standby.
5057	Power supply	During standby 31: Turns on the power When power is on 30: Turns off the power (Standby mode)
4950	Input	When power is on 32: COMP. 33: PC RS66 RS56 36: HDMI 1 37: HDMI 2
5243	Remote control	Sends the same code as the supplied remote control. • “Remote Control Code”p. 74

Operating command and data (binary code)

Command	Type	Description
5057	Power supply	During standby or when power is on 30: Standby mode 31: When power is on 32: In the Cool-down mode 34: When error occurs on this unit
4950	Input	When power is on 32: COMP. 33: PC RS66 RS56 36: HDMI 1 37: HDMI 2

End

This code indicates the end of communication. The binary code is fixed at “0A”.

Remote Control Code

Binary code is sent during communication.

- The following applies to the case when the remote control code is “A”. In the case of “B”, add “36” to the beginning of the code.

Remote Control Button Name	Binary Code
STAND BY	37 33 30 36
ON	37 33 30 35
HDMI 1	37 33 37 30
HDMI 2	37 33 37 31
COMP.	37 33 34 44
PC RS66 RS56	37 33 34 36
3D FORMAT	37 33 44 36
3D SETTING	37 33 44 35
LENS CONTROL	37 33 33 30
LENS MEMORY	37 33 44 34
LENS AP.	37 33 32 30
ANAMO.	37 33 43 35
HIDE	37 33 31 44
▲	37 33 30 31
▼	37 33 30 32
▶	37 33 33 34
◀	37 33 33 36
OK	37 33 32 46

Remote Control Button Name	Binary Code
MENU	37 33 32 45
BACK	37 33 30 33
FILM	37 33 36 39
CINEMA	37 33 36 38
ANIME	37 33 36 36
NATURAL	37 33 36 41
STAGE	37 33 36 37
3D	37 33 38 37
THX RS66 RS56	37 33 36 46
USER	37 33 44 37
C.M.D.	37 33 38 41
MPC RS66 RS56 RS48	37 33 46 30
INFO RS46	37 33 37 34
GAMMA	37 33 37 35
C. TEMP	37 33 37 36
COLOR PROFILE RS66 RS56 RS48	37 33 38 38
COLOR SPACE RS46	37 33 43 44
PIC. ADJ.	37 33 37 32

Communications Example

This section shows the communication examples of RS-232C.

Operating command

Type	Command	Description
Connection check	PC → This unit: 21 89 01 00 00 0A This unit → PC: 06 89 01 00 00 0A	Connection check
Power (On)	PC → This unit: 21 89 01 50 57 31 0A This unit → PC: 06 89 01 50 57 0A	When power is turned on from the Standby mode
Power (Off)	PC → This unit: 21 89 01 50 57 30 0A This unit → PC: 06 89 01 50 57 0A	When power is turned off (Standby mode) from power-on mode
Input (COMP.)	PC → This unit: 21 89 01 49 50 32 0A This unit → PC: 06 89 01 49 50 0A	When video input is set to component
Remote control (MENU)	PC → This unit: 21 89 01 52 43 37 33 32 45 0A This unit → PC: 06 89 01 52 43 0A	When the same operation as pressing the [MENU] button on the remote control is performed

Reference command

Type	Command	Description
Power (On)	PC → This unit: 3F 89 01 50 57 0A This unit → PC: 06 89 01 50 57 0A This unit → PC: 40 89 01 50 57 31 0A	When information on the power-on state is acquired
Input (HDMI 1)	PC → This unit: 3F 89 01 49 50 0A This unit → PC: 06 89 01 49 50 0A This unit → PC: 40 89 01 49 50 36 0A	When information on HDMI 1 input is acquired

Specifications

Product Name		D-ILA Projector
Model Name		DLA-RS66, DLA-RS56, DLA-RS48, DLA-RS46
Display Panel/Size		D-ILA device *1, 2 0.7" (1980 x 1080 pixels) x 3 (total no. of pixels: approx. 6.22 million)
Projection Lens		2.0 x power zoom lens (1.4:1 to 2.8:1), motorized zoom and focus
Light-source Lamp		230 W ultra-high pressure mercury lamp [model no.: PK-L2312U] Average lifespan: 4000 hours ("Low" mode)
Screen Size		Approx. 60" to 200" (Aspect ratio of 16:9)
Projection Distance		Refer to p. 77.
Input compatibility signal		Refer to p. 79.
Display Resolution		3840 x 2160 pixels (RS66 RS56 RS48) *3 1920 x 1080 pixels (RS46)
Input Terminal	Component Video Input	1 system, RCA pin jack x 3 Y: 1.0 Vp-p, 75Ω Pb/Cb, Pr/Cr: 0.7 Vp-p, 75Ω Also supports R/G/B Sync on G
	HDMI Input	2 system, HDMI 19-pin x 2 (HDCP-compatible) *4
	PC Input	1 system, D-sub 15-pin VGA (RS66 RS56)
Output Terminal	Trigger Terminal	1 system, Ø 3.5 mm DC Power Jack (⊖—⊕) DC OUT 12 V, 0.1 A
	3D synchro	Dedicated terminal for 3D SYNCHRO EMITTER (1 system, mini-DIN 3-pin)
Control Terminal	RS-232C Terminal	1 system, D-sub 9-pin (male) (external control)
	Remote Terminal	1 system, stereo mini jack (remote control)
	LAN Terminal	1 system, RJ-45 plug
Power Requirements		AC 110 to 240 V, 50/60 Hz
Power Consumption		360 W (during standby: 0.4 W) (RS66 RS56 RS48) 330 W (during standby: 0.4 W) (RS46)
Operation Environment		Temperature: 5°C to 35°C; humidity: 20% to 80%; storage temperature: -10°C to 60°C
Installation Height		Below 5000 ft (1524 m)
Dimensions (Width x Height x Depth)		Approx. 455 mm x 179 mm x 472 mm (excluding feet and protrusions)
Mass		15.4 kg (RS66 RS56) 15.1 kg (RS48) 14.8 kg (RS46)
Accessories		Refer to p. 11.

*1 D-ILA is the abbreviation for Direct drive Image Light Amplifier.

*2 D-ILA devices are manufactured using extremely high-precision technology with a pixel effectiveness of 99.99%. Only 0.01% or less of the pixels are either missing or would remain permanently lit.

*3 During 3D playback, the pixel is set to 1920 x 1080.

*4 HDCP is the abbreviation for High-bandwidth Digital Content Protection system. The image of the HDMI input terminal may not be displayed in some cases due to changes in the HDCP specifications.

- Design and specifications are subject to change without prior notice.
- Please note that some of the pictures and illustrations may have been abridged, enlarged or contextualized in order to aid comprehension. Images may differ from the actual product.

About Trademarks and Copyrights



HDMI, HDMI logo and High-Definition Multimedia Interface are trademarks or registered trademarks of HDMI Licensing LCC.

Screen Size and Projection Distance

When a 16:9 screen is used

Diagonal (Model)	Screen Size		Projection Distance	
	Width (mm)	Height (mm)	Wide-end (m)	Tele-end (m)
60	1328	747	1.78	3.66
70	1549	872	2.09	4.28
80	1771	996	2.4	4.89
90	1992	1121	2.7	5.51
100	2214	1245	3.01	6.13
110	2435	1370	3.31	6.75
120	2656	1494	3.62	7.36
130	2878	1619	3.92	7.98
140	3099	1743	4.23	8.60
150	3320	1868	4.53	9.22
160	3542	1992	4.84	9.84
170	3763	2117	5.14	10.45
180	3984	2241	5.45	11.07
190	4206	2366	5.75	11.68
200	4427	2490	6.06	12.30

When a 4:3 screen is used

Screen Size			Projection Distance	
Diagonal (Model)	Width (mm)	Height (mm)	Wide-end (m)	Tele-end (m)
60	1219	914	2.22	4.49
70	1422	1067	2.60	5.24
80	1626	1219	2.98	6.00
90	1829	1372	3.36	6.75
100	2032	1524	3.74	7.51
110	2235	1676	4.11	8.26
120	2438	1829	4.49	9.02
130	2642	1981	4.87	9.77
140	2845	2134	5.25	10.53
150	3048	2286	5.63	11.28
160	3251	2438	6.00	12.04

* Projection to a 4:3 screen larger than 163" is equivalent to a size that is larger than 200" in the 16:9 format, and is beyond our guarantee coverage.

When a 2.35:1 screen is used

Screen Size			Projection Distance	
Diagonal (Model)	Width (mm)	Height (mm)	Wide-end (m)	Tele-end (m)
60	1402	597	1.95	3.91
70	1636	696	2.28	4.56
80	1870	796	2.60	5.21
90	2103	895	2.93	5.86
100	2337	995	3.26	6.51
110	2571	1094	3.58	7.16
120	2805	1193	3.91	7.81
130	3038	1293	4.23	8.47
140	3272	1392	4.56	9.12
150	3506	1492	4.88	9.77
160	3740	1591	5.21	10.42
170	3973	1691	5.53	11.07
180	4207	1790	5.86	11.72
190	4441	1890	6.19	12.37
200	4674	1989	6.51	13.02

Types of Possible Input Signals

Video

Analog Video Signal		480i, 480p, 576i, 576p, 720p/50 Hz, 720p/60 Hz, 1080i/50 Hz, 1080i/60 Hz
Digital Video Signal		480i, 480p, 576i, 576p, 720p/50 Hz, 720p/60 Hz, 1080i/50 Hz, 1080i/60 Hz, 1080p/24 Hz, 1080p/50 Hz, 1080p/60 Hz
3D Signal	Frame Packing	720p/50 Hz, 720p/60 Hz, 1080p/24 Hz, 1080i/50 Hz, 1080i/60 Hz
	Side-by-side	1080i/60 Hz, 1080p/60 Hz, 1080i/50 Hz, 1080p/50 Hz, 1080p/24 Hz, 720p/50 Hz, 720p/60 Hz
	Top-and-bottom	720p/50 Hz, 720p/60 Hz, 1080p/24 Hz

PC signal (HDMI)

No.	Designation	Resolution	fh [kHz]	fv [Hz]	dot CLK [MHz]	Total No. of Dots [dot]	Total No. of Lines [line]	No. of Effective Dots [dot]	No. of Effective Lines [line]
1	VGA 60	640×480	31,500	60,000	25,200	800	525	640	480
2	VGA 59.94	640×480	31,469	59,940	25,175	800	525	640	480
3	SVGA 60	800×600	37,879	60,317	40,000	1.056	628	800	600
4	XGA 60	1024×768	48,363	60,004	65,000	1.344	806	1.024	768
5	WXGA 60	1280×768	47,760	60,000	79,998	1.675	796	1.280	768
6	WXGA+ 60	1440×900	55,919	59,999	106,470	1.904	932	1.440	900
7	SXGA 60	1280×1024	63,981	60,020	108,000	1.688	1.066	1.280	1.024
8	WSXGA+ 60	1680×1050	65,222	60,002	147,140	2.256	1.087	1.680	1.050
9	WUXGA 60	1920×1200	74,038	59.95	154,000	2.080	1.235	1.920	1.200

PC signal (D-sub 3-line 15-pin)

No.	Designation	Resolution	fh [kHz]	fv [Hz]	dot CLK [MHz]	Total No. of Dots [dot]	Total No. of Lines [line]	No. of Effective Dots [dot]	No. of Effective Lines [line]
1	VGA 60	640×480	31,500	60,000	25,175	800	525	640	480
2	VGA 72	640×480	37,900	72,000	31,500	832	520	640	480
3	VGA 75	640×480	37,500	75,000	31,500	840	500	640	480
4	VGA 85	640×480	43,300	85,000	36,000	832	509	640	480
5	SVGA 56	800×600	35,200	56,000	36,000	1024	625	800	600
6	SVGA 60	800×600	37,900	60,000	40,000	1056	628	800	600
7	SVGA 72	800×600	48,100	72,000	50,000	1040	666	800	600
8	SVGA 75	800×600	46,900	75,000	49,500	1056	625	800	600
9	SVGA 85	800×600	53,700	85,000	56,250	1048	631	800	600
10	XGA 60	1024×768	48,400	60,000	65,000	1344	806	1024	768
11	XGA 70	1024×768	56,500	70,000	75,000	1328	806	1024	768
12	XGA 75	1024×768	60,000	75,000	75,750	1312	800	1024	768
13	XGA 85	1024×768	68,700	85,000	94,500	1376	808	1024	768
14	WXGA 60	1280×768	47,760	60,000	79,998	1675	796	1280	768
15	WXGA+ 60	1440×900	55,919	59,999	106,470	1904	932	1440	900
16	SXGA 60	1280×1024	64,000	60,000	108,000	1688	1066	1280	1024
17	SXGA+ 60	1400×1050	63,981	60,020	108,000	1688	1066	1400	1050
18	WSXGA+ 60	1680×1050	65,222	60,002	147,140	2256	1087	1680	1050
19	1920×1080 60	1920×1080	67,500	60.00	148,500	2200	1125	1920	1080
20	MAC13"	640×480	35,000	66,667	30,240	864	525	640	480
21	MAC16"	832×624	49,107	75,087	55,000	1120	654	832	624
22	MAC19"	1024×768	60,241	74,927	80,000	1328	804	1024	768

* Even when signals can be input, video images may not be projected properly depending on the PC or cable in use. When this occurs, switching to another compatible resolution or changing the cable may help to resolve the problem in some cases.

Indicator Display on the Main Unit

Meaning of the lighting figures



The indicator lights up.



The indicator appears blinking.

Operation mode display

Displays using the different colors and solid/blinking light of the “STANDBY/ON” indicator.

“STANDBY/ON” lights up (red)
In standby state

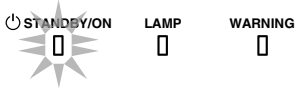

“STANDBY/ON” lights up (green)
During lamp startup

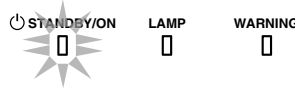

All lights off
During projection



“STANDBY/ON” blinking (red)
In the Cool-down mode

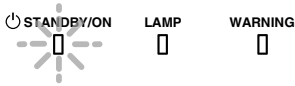

“STANDBY/ON” blinking (green)
When the video image is temporarily hidden (HIDE is on)

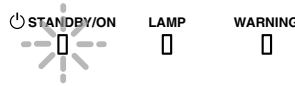

Estimated timing for lamp replacement

Displays using the solid/blinking light of the “LAMP” indicator. The “STANDBY/ON” indicator, which shows the operating mode of the unit, is displayed simultaneously as described above.

“LAMP” lights up (orange)











When lamp replacement is near (lamp time has exceeded 2900 hours)

Warning display

You can tell the details of a warning from the (repeated) displays of the “WARNING” and “LAMP” indicators. The “STANDBY/ON” indicator, which shows the operating mode of the unit, is displayed simultaneously as described above. The Warning mode is activated once the message is displayed. Projection is interrupted, and the cooling fan is turned on for about 60 seconds.

The power cannot be turned on again while cooling is in progress. Check the following after cooling is complete.

Indicator Status (Solid/Blinking)	Blinking Frequency	Description	Check and Countermeasure
   Mode Display (*) (Red)	x1	Abnormality in the power supply	<ul style="list-style-type: none"> • Check that nothing is blocking the air inlets. • Check that the external temperature is normal. Countermeasure: Leave the unit unoperated until it cools down. After that, turn on the power again.
	x2	Cooling fan stopped abnormally	
	x3	Internal temperature is abnormally high	
	x4	External temperature is too high	
	x5	Abnormal circuit operation RS66 RS56 RS48	
   Mode Display (Orange) (Red) Blinking Simultaneously	x1	Abnormal circuit operation	<ul style="list-style-type: none"> • Check that nothing is blocking the auto lens cover. Countermeasure: Turn on the power again.
	x2		
	x3		
	x4	Abnormal operation of the automatic lens cover	
   Mode Display (Orange) (Red)	x1	Lamp does not light up and unit is unable to project	<ul style="list-style-type: none"> • Check that the lamp unit and lamp cover are correctly installed. Countermeasure: Turn on the power again.
	x2	Lamp goes out during projection	
	x3	Lamp cover is removed	

If the Warning mode is activated again, wait for the cooling fan to stop, followed by pulling out the power plug from the outlet.

Request for repair at your authorized dealer or a nearby service center.

(*) If the scheduled time for lamp replacement is exceeded, the indicator may light up.

Dimensions

(Unit: mm)

Top Surface

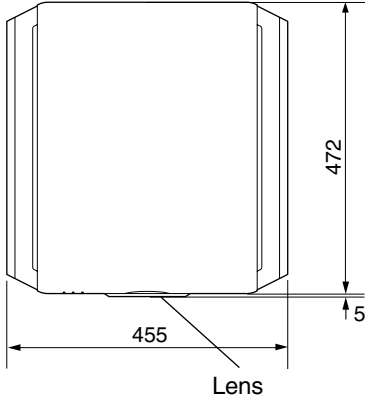

Bottom Surface

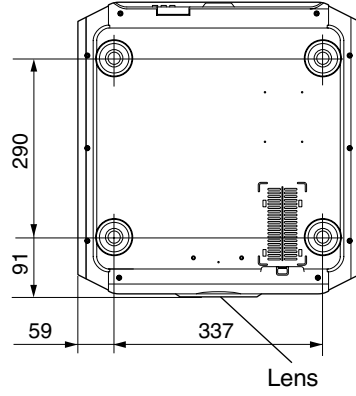

Front

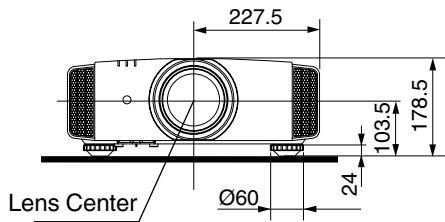

Rear Surface

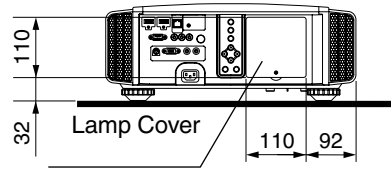

- The illustrations show the connection terminals of **RS66** **RS56**.
- The dimensions are identical for all the models.

Index

A	Accessories	11	HDMI Input Level	53	
	Adjusting Details of the Image Quality	41	HDMI Input Link	53	
	Adjusting Distortion of the Projection Screen	28	HDMI Input Terminal	22	
	Adjustment and Setting by the Menu	47	HIDE	26	
	Adjustment of the Image Quality	49	High Altitude Mode	62	
	Advanced Menu	51			
	ANAMO.	57	I	Indicator Display	81
	Anamorphic	57		Input Resolution	64, 79
	Aspect	33		Input Signal	64, 79
				Input terminals	16
B	Back Color	61		Installation Method	19
	Basic Setting of the Image Quality	37		Installing the 3D Syncro Emitter	34
	Black Level	57			
	Brightness	50	K	Keystone Correction	57
C	C.M.D (Clear Motion Drive)	46	L	Lamp	11
	Ceiling Mount	20		Lamp Power	52
	Cleaning and Replacing the Filter	68		Lamp Time	64
	Clear Motion Drive	46		Language Selection	61
	Color Density	50		Lens	14
	Color Management	45		LENS AP.	52
	COLOR P.FILE	38		Lens Aperture	52
	Color Profile	38		Lens Control	28
	Color Shade	50		Lens cover	14
	Color Space	51		Lens Cover	11
	Color Temperature	49		Lens Memory	28
	Communication Terminal	62		Lens Shift	28
	COMP (Component Video)	23, 53		Line Display	61
	Connection	22		Logo Display	61
	Contrast	50			
	Controls and Features	14	M	Main Features	12
	Custom Gamma	43		Menu Display	61
				Menu Items	47
D	Dimensions	83		Menu Position	61
	Display Position	54		MPC LEVEL	40
	Distortion Correction	57			
			N	Network	62
E	Eco Mode	62		NR	51
	Environment Correction	31			
	External Control	72	O	Off Timer	62
				Optional Accessories	11
F	Filter Product no.	68			
	Filter Replacement	68	P	PC	23, 54
	Focus	29		PIC. ADJ.	50
	Frame Interpolation	46		Picture Mode	37
	Frame Packing	35		Picture Tone	50
				Pixel Adjustment	55
G	GAMMA	41		Precautions during Installation	19
	Gamma Adjustment	41		Progressive	54
				Projection Distance	77
H	HDMI Color Space	53			

R	Remote Control	17	Troubleshooting	69
	Replacing the Lamp	65		
	Resetting the Lamp	63	U	User Name Edit
	RGB	23, 53		52
	RS-232C	24	V	Viewing 3D Movies
				34
				Viewing Videos
				26
S	Screen Correction	32	W	When the following messages appear...
	Screen Mask	54		71
	Screen Size and Projection Distance	77	Z	Zoom
	Shadow/Highlight Correction	44		29
	Sharpness	51		
	Shift	29	Symbol	
	Side by Side	35	2D/3D Conversion	35
	Signal Display	64	3D Caption Correction	36
	Software Ver.	64	3D Crosstalk Cancel	36
	Specifications	76	3D Depth Correction	36
			3D Format	35
			3D Glasses3D Glasses	11, 34
T	THX	13	3D Setting3D Setting	35, 54
	Top and Bottom	35	3D Synchro Emitter3D Synchro Emitter	11, 34
	Trigger	62	4K Profile	40

DLA-RS66
DLA-RS56
DLA-RS48
DLA-RS46
D-LILA PROJECTOR

JVC